

# Wireless World

RADIO and ELECTRONICS



MAY 1945

1/6

Vol. LI. No. 5

IN THIS  
ISSUE:

FREQUENCY ALLOCATION PROBLEMS

# PRIMER ON RUBBER BONDING

NUMBER

11

IN SERIES

*An Aero-Engine Mounting required the following characteristics:*

**FLEXIBILITY** was needed to insulate the airframe from—

- (a) Torsional movements of engine about longitudinal C.G. axis.
- (b) Vertical forces and couples in the vertical plane.

**STIFFNESS** was needed to prevent—

- (a) Fore and aft movement of engine due to airscrew "pull" which would upset control settings.
- (b) Transverse "yawing" of engine.

**SPACE WAS LIMITED**—therefore a multi-bush type of mounting was adopted.

**PRECAUTIONS** had to be taken to limit the vertical shear movement.

*As Moulded*

Simple three-bush moulding.

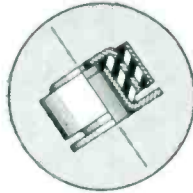

*As Assembled*

Two mouldings with loose central tube.

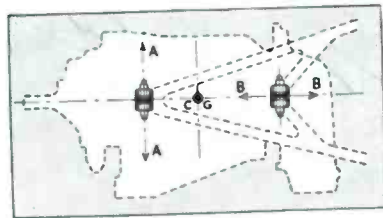

*As Installed*

Vertical shear movement in direction of arrow "A" (limited by stops); horizontal compression movement in direction of arrow "B" (high resistance).

*You may wonder whether a bonded product would solve your problem. We should know — if you asked us.*

R.R.34



## RUBBER BONDERS LTD.

ENGINEERS IN RUBBER BONDED TO METAL

FLEXILANT WORKS · DUNSTABLE · BEDS.





THE Services and war-time industry are familiar with the high standard of dependable accuracy of "AVO" Electrical Testing Instruments. They will be an equally dominant factor in the post-war rebuilding of our great industries and the advancement of amenities worthy of a world at well-earned peace.

• In the belligerent interim, orders can only be accepted which bear Government Contract Number and Priority Rating.

Sole Proprietors & Manufacturers:-  
**THE AUTOMATIC COIL WINDER & ELECTRICAL EQUIPMENT CO., LTD**  
 WINDER HOUSE · DOUGLAS STREET · LONDON · S.W.1 · TELEPHONE VICTORIA 3111

Orders bearing Government Contract Numbers and Priority Rating can now be accepted for quick delivery of the following two "AVO" instruments:-

**THE "AVO" TEST BRIDGE**

A portable self-contained 50-cycles bridge of exceptional accuracy and utility for direct measurement of all normal values of condensers and resistances. Facilities also provided for condenser power factor measurements and leakage tests by the flashing neon method, resistance, capacity and large inductance measurements against external standards. May also be used as a highly efficient valve voltmeter indicator for measurement of both audio and radio frequency voltages.

**THE ALL-WAVE "AVO" OSCILLATOR**

An inexpensive, accurate modulated oscillator covering a continuous fundamental frequency band from 35 Kc. to 40 Mc. A harmonic calibration extends the range to 80 Mc. A large clearly marked dial is directly calibrated throughout, accuracy being within 1%. Externally modulated, internally modulated, or R.F. signals obtainable at will. Calibrated double attenuator enables signal to be varied from a few microvolts to 50 millivolts, with a force output of 1 v. Self-contained, fully shielded.

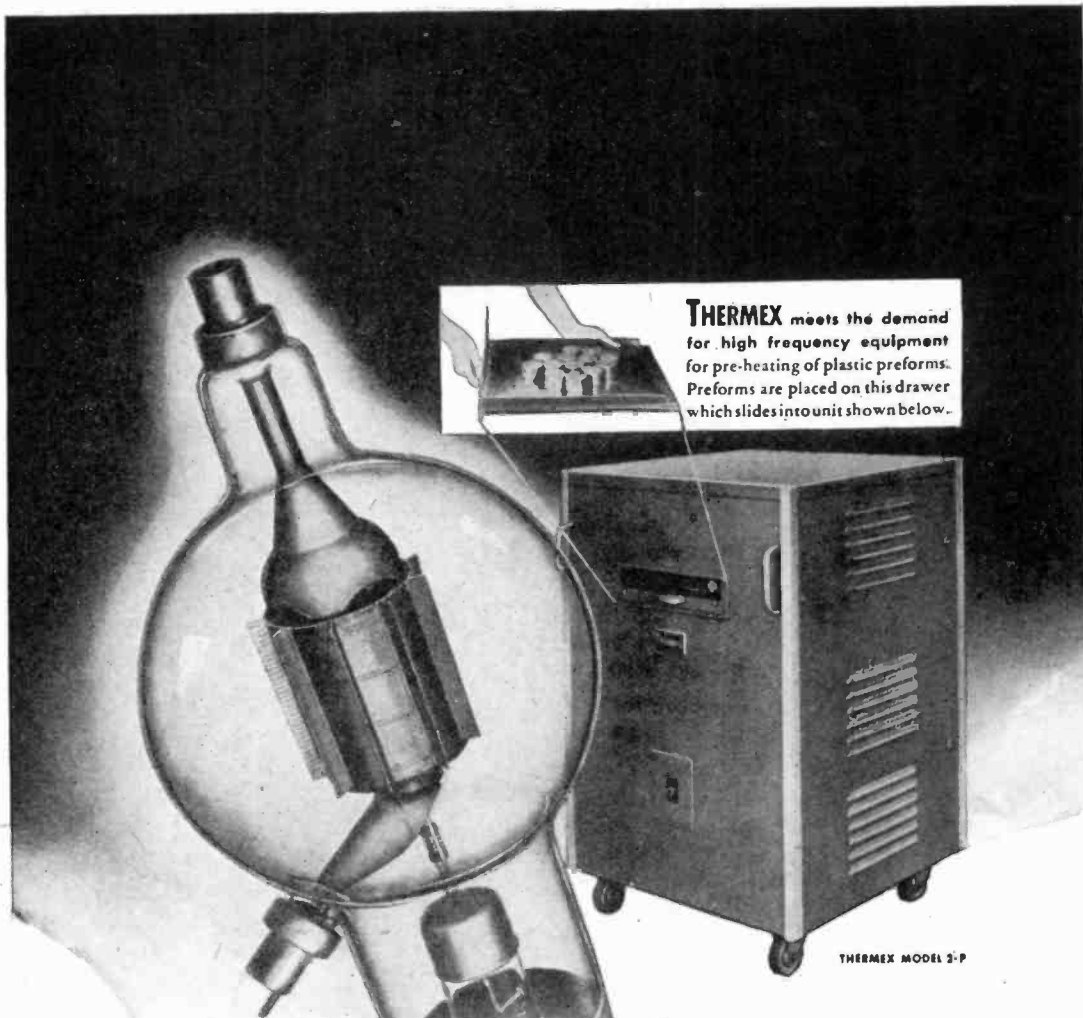

## Of course it uses Eimac valves

This compact Thermex unit measures 28 inches by 28 inches, stands 47 inches high, and weighs only 614 pounds. It is a practical and flexible piece of equipment with built-in heating cabinet and removable 12 inch by 15 inch drawer-electrode.

Being completely automatic, there is nothing to do but plug this Thermex in and load and unload the preform drawer. No dials, no tuning, not even a button to push. Closing the preform drawer all the way in, turns on the high frequency power and timer. At the end of the prescribed time, which may be anywhere from 5 to 10 seconds up to 2 minutes, the red indicating light goes out; the operator removes the tray and unloads the preforms into the mold cavities.

The Thermex Model No. 2-P, which is illustrated, operates at a frequency of 25 to 30 megacycles using 250 volt 60 cycle single phase current. It has an output in excess of 3400 BTUs per hour, and it uses a pair of Eimac 450-TH valves. The use of electronic heating has increased production for many plastic manufacturers who

have been leaders in utilizing the science of electronics.

The Thermex Division of the Girdler Corporation of Louisville, Ky., is a leader in supplying equipment for this and other industrial applications. It's natural that Eimac valves are used, since these valves are first choice of leading electronic engineers throughout the world.

Follow the leaders to

**Eimac**  
VALVES

EITEL-McCULLOUGH, Inc.

985 San Mateo Avenue, San Bruno, California

Plants located at: San Bruno, California and Salt Lake City, Utah  
Export Agents: Frezza & Hansen, 201 Clay St., San Francisco 11, California, U.S.A.



Eimac has received 7 ARMY-NAVY "B" AWARDS for production efficiency - San Bruno 5, Salt Lake City 2

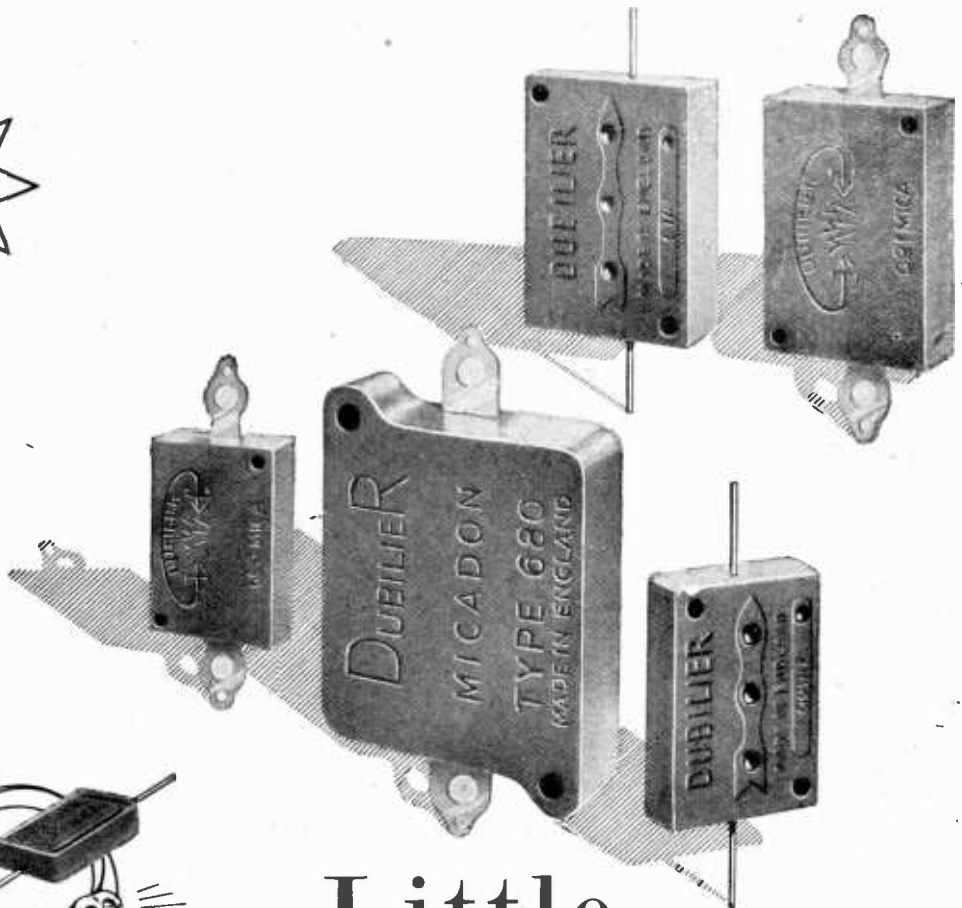
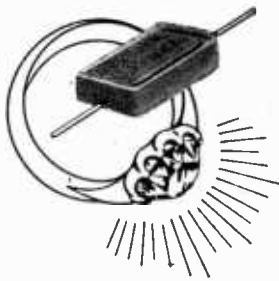

## Little and Good

NOTHING very exciting to look at perhaps. But these Dubilier moulded Mica Capacitors are doing a great job. Dubilier initiative pioneered the original Mica Capacitor from its infancy, thus developing a 100% British product that makes Dubilier the accepted leaders of this type. Notice the tiny proportion of Type 635. It has to be good to be so small and since it is Dubilier made, it is good; like all its bigger brothers.

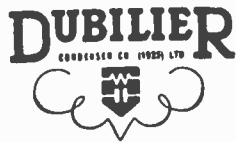

*The name is . . . Dubilier*

# ◆ LINAGLOW LIMITED ◆

**offer**

**T.R.F. 3-WAVEBAND 4-VALVE CONSTRUCTORS KIT, 17-2,000 m.**



Aluminium screened coils, excellent short-wave reception (the special coils used in this circuit give a performance equal to a superhet), 4½ watts output, complete with loud-speaker, all parts, wiring and theoretical diagram—nothing extra to purchase. Chassis dim.: 12in. x 6in. x 6in. to top of dial. 200/250 v. A.C. **11½ Gns.** Including Tax Case and packing, 5/- extra.

**RADIO MECHANICS' SIDE CUTTERS**, ex-Govt. stock, reconditioned like new, exceptionally cheap, 4/6.  
**VARIABLE CONDENSERS**. 3-gang (small), .0005 ceramic with trimmers, fixing feet, slow-motion drive, dial frame and pointer. 17/9. 3-gang, .0005 ceramic insulation with slow-motion drive, pointer and dial frame, 12/6. 3-gang .0005 ceramic insulation. Special offer, 7/9.

**SERVICE KITS**

**85.** 1 8-mfd. 400/500 v. Electrolytic. 12 each assorted tubular paper condensers. Carbon Wire End Resistors. New, ex-televison. 2 yds. sleeving, 10/9.  
**86.** 1 8-mfd. 400/500 v., 132-mfd. 320 v. Electrolytics. 25 each assorted tubular paper condensers and carbon wire end resistors. 1 Volume Control. New, ex-televison. 3 yds. sleeving, 25/-.  
**87.** 2 8-mfd. 400/500 v. 1 4-mfd. 400/500 v. 1 32-mfd. 320 v. Electrolytics. 12 each assorted tubular paper condensers and carbon wire end resistors. New, ex-televison. 2 volume controls, 39/6.  
**88.** 3 8-mfd. 400/500 v., 3 32-mfd. 320 v., 1 8 x 8-mfd. 400/500 v. 2 4-mfd. 400/500 v. 25 each assorted tubular paper condensers, and carbon wire end resistors. 6 yds. sleeving. 6 yds. P.V.C. cable, 3 tone controls, 6 assorted valveholders. New, ex-televison. **25.**

**N.B.**—Owing to depleted staff, we can only accept Cash with order. No C.O.D. Delivery 14 days.

**VOLUME CONTROLS**. 1, 5, 10, 20, 25, 50 and 100 thousand ohms. ½, 1 and 2 meg., without switch, 4/9 each. As above, with switch, 6/9; 100,000 ohms. ½ meg., double pole switch, best American, 7/6. 2,000 ohms only, wire wound, 3/-, 1,000 ohms only, carbon, with screw adjustment, 1/6 each. Midget, ½ meg., with switch, 7/6.  
**ENAMELLED COPPER WIRE**. 30 s.w.g., 1 lb. spools 5/- per spool.  
**LINE CORDS**, 3-way heavy duty, 3 amp., 360 ohms, 9/6. 480 ohms, 13/6. 600 ohms, 15/6. 2-way, 360 ohms, 5/6. 480 ohms, 7/6. 600 ohms, 9/3.  
**WIRE-END CARBON RESISTORS**. ½, 1 and 2 watt, Manufacturers' types. New, ex-televison. Parcel of 50 assorted, 12/6.  
**TUBULAR PAPER CONDENSERS**. 350/500 v. D.C. working. New, ex-televison. .0001, 3/-; .0025, 4/-; .01, 6/-; .02, 7/-; .04, 8/-; .08, 9/-; 1, 10/-; 25, 12/-; .5, 21/- per dozen. Parcel of 50 assorted, 22/6.  
**SYNCHRONOUS MOTOR**, 200/250v., A.C., 12 m.a., suitable for adaptation for electric clocks, time switches, etc. Speed of rota, 200 r.p.m. Supplied with spare gears, 27/6.  
**RELAYS**. Complete with circuit breaking switch, 200/250 v. A.C., 60/80 v. D.C., 300 m.a., 15-amp. switch, each 7/6.  
**REVOLUTION COUNTERS**. 0-999 with gear drive and gears, 3/6.

**ELECTRIC KETTLES**

3-pint 950-watt heavily tinned throughout, 200/250 volt. Complete with lead and connector. **30/-** Each

**ELECTRIC SMOOTHING IRONS**

4½ lbs., 200/250 volts. Wartime finish. **26/6** Complete with lead. Price

**VALVE HOLDERS**. Amphenol type. International or English octal, chassis mounting, 1/- each. 10/6 per dozen. English wafer type, 4-, 8-pin, 5 for 2/6.  
**SUPERIOR QUALITY KNOBS**. Ex-televison. Suitable for radio, for ½in. spindles. ½in. with grub screw, 9d. each. 2in., 1/9. White Ivorine, ½in. with grub screw, 9d. each.  
**WESTINGHOUSE H.W. DETECTOR**. 36 v., R.M.S. 0.25 m.a., 5/6. H1 metal rectifier, 2½ v., D.C., 10 m.a., 3/6.  
**PUSH-BUTTON UNITS**. Complete with eucutcheon and knobs, 4-way, new, 6/-.  
**L.F. CHOKES**. 20 henrys, 150 m.a., 16/9.  
**SLOW-MOTION DRIVE**. 8-1. Complete with drum and spindle, 3/-.  
**WIRE WOUND RESISTORS**. 50-1,500 ohms, 5-watt type, 1/9 ea.; 10-watt type, 2/8 ea.  
**VALVE HOLDERS—AMPHENOL TYPE**. International or English Octal, chassis mounting, 1/- ea., 10/6 per dozen. English wafer type, 4-, 8-pin, 6 for 2/6.  
**HIGH VOLTAGE BRAIDED SLEEVING**. 1 and 1½ mm., first-class quality, 3/6 per dozen yards.  
**P.V.C. CABLE**. 14/30, Red, Green, Blue, Yellow and Black. 2/- per dozen yards.  
**MAINS DROPPER RESISTORS**. .2 amp. 950 ohms, with fixing feet 6/9 ea.  
**SCREENED LEADS**. 4ft. 6in. long, fitted 4 wander plugs, 1/9 ea.  
**INSULATION LEADS**. 8ft. long, fitted 4 wander plugs and 2 Holdite clips, 4/6 ea.  
**WAXER PLUGS**, in 2 colours. 3 - dozen.

**MAINS TRANSFORMERS**. 350-0-350 4 v. 6 amp. C.T. 4 v. 2 amp., 100 m.a.; Heavy laminations pre-war stock. Bargain, 27/6; 350-0-350 6.3 v. 3 amp., C.T., 5 v. 2 amp., 100 m.a., 32/6.  
**LOUDSPEAKER TRANSFORMERS**. Pentode Output 40:1, 50 m.a., 4/6. Midget Multi-Ratio 60:1, 80:1, 40 m.a., 9/6. Multi-Ratio 40:1, 60:1, 80:1, and push-pull 80 m.a., 12/6. Pentode Output 12/15 ohms, 100 m.a., 12/6. Heavy 250 and 800 ohms, 35/-, B.T.H. Model R.K., 10in. Mains Energised Energised Loudspeakers, 1,000 ohms field, 15 ohms speech, weight 28 lbs., reconditioned as new. Ideal for P.A. work, 26.6.0. See transformers, above, to suit.  
**AERIAL AND OSCILLATOR COILS**. Best D.S.C. wire wound, colour coded on bakelite formers. Short, Medium and Long Wave. 16/50m.; 200/550m.; 1,000/2,000m.; with circuit diagram, 15/- the set.

**ALL-WAVE SERVICE SIGNAL GENERATOR**

A.C. Mains 200/250 v., 50 cycles. Range covers from 20 M.C. to 100 K.C., all fundamentally in 5 bands without gaps. S/M Dial Direct calibration in frequencies. Coarse and fine output attenuator. Internal modulation 400 C/S. Iron-cored coils. The Generator is entirely screened in heavy metal cabinet with carrying handle. Dim.: 10in. x 10in. **£13 10 0** Each

**F. TRANSFORMERS**. 465 K.C.s. Iron-cored Litz wound, aluminium can. Limited quantity. 17/6 matched pair, 9/6 each.  
**S.M. & L. T.R.F. COILS**. Phillips, best quality in screened aluminium cans, 17-51, 290-585, 725-2,000 metres. (These coils equal to performance of superhet.) Complete with circuit diagram, 9/6 the pair.  
**M. & L. T.R.F. AERIAL COILS**. Aluminium screened Phillips, 200-585, 725-2,000 metres, complete with circuit diagram, 2/9 each.  
**WAVE CHANGE SWITCH**, to suit all above coils, 5/9 each.  
**SCREENED INTERLACED FLEXIBLE MICROPHONE CABLE**. Twin 6 yards for 6/9. Single 1/- per yard.  
**VALVES**. American Types, at B.O.T. controlled retail prices. For replacement purposes only. 6P5, 12F5, 12V5, 129F5, 1H5, 9J2; 5Y3, 1C5, 1N5, 11/-; 6Q7, 1207, 11/7; 6F5, 6K6, 6K7, 6L7, 12X7, 129J7, 36, 1A7, 6V6, 12/10; 6A8, 6B7, 68A7, 14/-.  
 Also British valves at manufacturers' List Prices. 6X5, U4, U6, 11/-; H141DD, TDD4, 11/7; AC/VP2, CL4, EF39, KTW61, PEN 45, 8P41, 8P42, T41, VP41, 12/10. D1 Diode lin. Peanut valve, with valveholder, 18/10; ECR3, FC13, X63, 12Z3, 12Z5, 35Z4, 14/-; AC9 Pen\*, EL35, Pen 46\*, U21, 15/3. Prices include Purchase Tax; add 3d. per valve post. \*Post Office permit necessary.  
**RADIO MECHANICS' LONG-NOSED PLIERS**, ex-Govt. stock, reconditioned like new, exceptionally cheap, 4/-. Extra long-nosed, 8½in., 10/6.

<p>◆ <b>CALLERS to Show Rooms,</b>  <b>2 HIGHGATE HIGH ST., N.6.</b>                  'Phone: MOUntview 9431</p>	<p><b>LINAGLOW LIMITED</b>                  HOURS OF BUSINESS: Mon. to Fri.                  9 a.m. to 5.30 p.m.                  Nearest Tube—Archway</p>	<p>◆ <b>POST ORDERS to Dept. M.O.40,</b>  <b>61 HIGHGATE HIGH STREET, N.6.</b>                  'Phone: MOUntview 9432</p>
--	--	--

Varley

TRANSFORMERS  
and CHOKES  
For RELIABILITY

SEND US YOUR ENQUIRIES

OLIVER PELL CONTROL LTD.

CAMBRIDGE ROW, BURRAGE ROAD, WOOLWICH, LONDON SE

Superspeed

CORED  
SOLDER

A.I.D. APPROVED

H. J. ENTHOVEN & SONS LTD.

230 THORNTON ROAD, WEST CROYDON, SURREY  
 THORNTON Heath 2462

1 2 3 inches



**BELLING & LEE LTD**  
CAMBRIDGE ARTERIAL ROAD, ENFIELD, MIDDX

GA



Manufacturers  
of

Switchboard and Port-  
able Pattern Microam-  
meters: Milliammeters:  
Ammeters: Voltmeters:  
Wattmeters and Testing  
Sets.



**MEASURING INSTRUMENTS (PULLIN) LTD.**  
ELECTRIN WORKS, WINCHESTER STREET, ACTON, W.3.

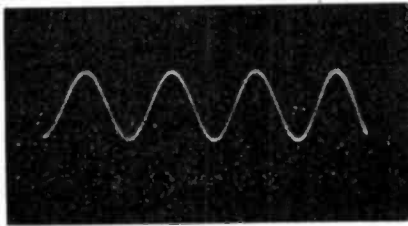

**B.S.R. STANDARD SINE WAVE SOURCES**  
**TYPE LO.800A. OSCILLATOR**

—an actual oscillogram of output voltage is illustrated—gives good waveform even below 10 c.p.s. This necessitates a minimum "pull-in" between the two H.F. oscillators. Superlative design results in an almost perfect waveform from the lowest to highest frequencies. The output voltage is constant to within a few per cent. over the frequency range. This Model is chosen as a Standard by most Departments. Stable, reliable. Indispensable to all serious workers.

Output up to 5 watts. Three range output voltmeter

incorporated—0-250, 0-50, 0-10.

Four output impedances, 5000,

1000, 600 and 15 ohms.

Frequency ranges (3 models),

0-15000, 0-25000 and 0-50000

c.p.s.

**BIRMINGHAM SOUND  
REPRODUCERS LTD.,**

Claremont Works, Old Hill, Staffs.

Cradley Heath B212/3. Grams: Electronics, Old Hill



**Wharfedale**  
**MIDGET 3½-inch UNIT**

**ALCOMAX MAGNET**

Flux Density 8,000 lines

Speech Coil 15 ohms or 2/3 ohms.  
The first Wharfedale Unit using  
the new ALCOMAX magnet  
steel which gives extremely high  
flux density with small size.  
Designed for use as Microphone  
or Midget Speaker. Very sensitive.

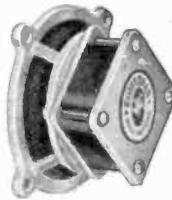

PRICE

**28/6**

(list)

Supplies are available for  
**PRIORITY ORDERS ONLY**

**WHARFEDALE**  
**WIRELESS WORKS**

(Sole Proprietor: D. E. BRIGGS)

HUTCHINSON LANE · BRIGHOUSE · YORKS

'Phone: BRIGHOUSE 50.

Telegrams: "WHARFDEL."



**F.W.S.CO.**

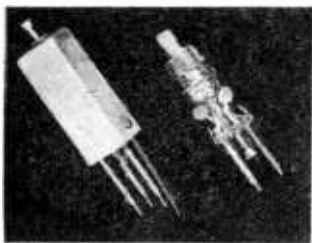

**WORLD'S LARGEST RADIO COIL MANUFACTURERS**

RADIO FREQUENCY INDUCTORS  
INTERMEDIATE FREQUENCY TRANSFORMERS

RADIO FREQUENCY COIL CHOKES

MICA COMPRESSION CONDENSERS

AIR DIELECTRIC CONDENSERS  
MICA MOULDED CONDENSERS

SICKLES SILVER CAP CONDENSERS

GANGED PERMEABILITY TUNING COMMUNICATIONS EQUIPMENT

F.M. EQUIPMENT PARTS  
U.H.F. RADIO EQUIPMENT

SPECIAL ELECTRONIC EQUIPMENT

**The F. W. SICKLES Co.**  
CHICOPEE, MASS., U.S.A.



They fit inside a delicate ring, they are so small; but they are mighty in dependable performance for hearing aid apparatus. Long lived with low battery drain, RAYTHEON Flat hearing aid tubes give quality performance for electronic hearing aids.

**RAYTHEON**

PRODUCTION CORPORATION  
HEARING AID TUBE DIVISION  
Newton, Massachusetts.



ARMY-NAVY "E" WITH STARS  
Awarded all four Divisions of Raytheon for Continued Excellence in Production.

**P. R. MALLORY & CO. Inc.**  
**MALLORY**

**VIBRATORS**  
ARE ALWAYS DEPENDABLE.

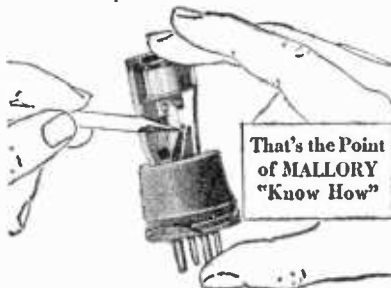

Contacts in a vibrator take a lot of punishment. They must operate under widely varying conditions of temperature and must "make and break" 115 times a second. Small wonder that alert engineers think of contacts first when selecting a vibrator!

For over 20 years, Mallory has been Industrial headquarters for every type of electrical contact. It has introduced new contact compositions . . . evolved better designs . . . formulated improved surface finishes.

As a result of this wide experience, Mallory equips its vibrators with special grade tungsten contacts which are cut in its own plant from material made to its own specifications. They give longer life, are subject to a minimum of erosion and transfer.

Mallory is ready to apply its special vibrator "know how" to your specific applications.

**P. R. MALLORY & CO. INC.**  
INDIANAPOLIS, INDIANA,  
U.S.A.

Radio and Electronics Division

ALSO  
"MYKROY" CERAMIC  
INSULATING MATERIALS  
GENERAL ELECTRONIC  
VACUUM CONDENSERS

**FOR THE FUTURE**

These Manufacturers will help solve your post-war problems.

Register your name now for full details which will be sent you when supply conditions again permit.

**FRANK  
HEAVER**

LIMITED

Kingsley Road, BIDEFORD,  
N. Devon

**G.I.**

**VICTORY PRODUCTION**

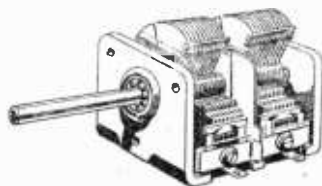

TYPE 2600 MIDGET  
VARIABLE CONDENSER

WHEN the mission of complete victory is accomplished, General Instrument will help "Win the Peace" by making the best use of still greater knowledge and experience in the manufacture of variable condensers and drives.

**THE GENERAL INSTRUMENT CORPORATION**  
ELIZABETH, N.J., U.S.A.



TWO-WAY radio communication systems, like the plastic-cased beauty illustrated, are one of the new developments leading industrial designers are thinking of to speed the work of a busy post-war world. Applications of this compact, plastic-cased 'walkie-talkie' are almost unlimited. Naturally, this is only one of thousands of uses plastics will be put to after the war, but it will serve to remind you that post-war planning is being done . . . Kurz-Kasch designers, engineers, tool-makers and moulders . . . specialists for a generation in plastic planning and moulding will help you with your problems.



**KURZ-KASCH INC.**  
Planners and Moulders for the Age of Plastics  
DAYTON · OHIO · U.S.A.

# Production simplified

## Solve Your Assembly Problems

with Lasso pressure sensitive adhesive tape. Printed with legible inscriptions spaced at regular intervals to suit the particular cable, pipe diameter, or size of component on to which it is to be applied. Supplied in various colours to B.S.C. Specification. Particularly suitable for pre-assembly where unskilled labour is used. Enables parts to be instantly identified.

★ *Durable, indelible, waterproof, fluid resistant, heat resistant, fix at any point, suitable for pre-assembly or after installation of components.*



*Supplies of Lasso Tape are available only for high priority work owing to restrictions on raw materials.*

**CABLE ASSEMBLIES LTD. (Subsidiary of Herts Pharmaceuticals Ltd.) BESSEMER ROAD, WELWYN GARDEN CITY**

Hermetically sealed  
to resist heat  
and moisture



## B.I. MOULDED TUBULAR CAPACITORS

Manufactured in a wide range of capacities and for working voltages up to and including 6,000 D.C. For high-voltage operation they provide the most effective solution where size and weight are important considerations and are designed to operate continuously in extremely arduous conditions of temperature and humidity. Manufactured in three sizes and supplied with soldering tags at each end, or alternatively with one soldering tag and a stud for base fixing.

**BRITISH INSULATED CABLES LTD.**  
Head Office • Prescot • Lancashire

Action stations...



She manoeuvres for position to attack . . . eyes are fixed on the Commander as he gives the enemy's bearing, range, course, speed. He orders the torpedoes to be fired . . . Once more Masteradio electrical equipment has helped to keep our sea lanes clear.

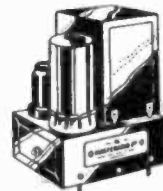

## Masteradio VIBRATORPACKS

As supplied to the ADMIRALTY, WAR OFFICE, AIR MINISTRY,  
POST OFFICE and other GOVERNMENT DEPARTMENTS

**MASTERADIO LTD • VIBRANT WORKS • WATFORD HERTS**



**How much can you condense a condenser**

*Midget*  *Condensers*

Midgets in size but giants in performance are these U.I.C. Miniature Condensers. Especially suitable for use in the latest Service type miniature radio transmitters and receivers, they are efficient and dependable under all climatic conditions. Made to specification K.110. Type approved. Full details on request.

UNITED INSULATOR CO. LTD., 12-22, LAYSTALL STREET, LONDON, E.C.1.

Tel: Terminus 7383 (5 lines) Grams: Calanel, Smith, London.

THE PIONEERS OF LOW-LOSS CERAMICS

Listen to the   
**Stentorian**  
 S P E A K E R S

better wait . . .  
 we're coming back

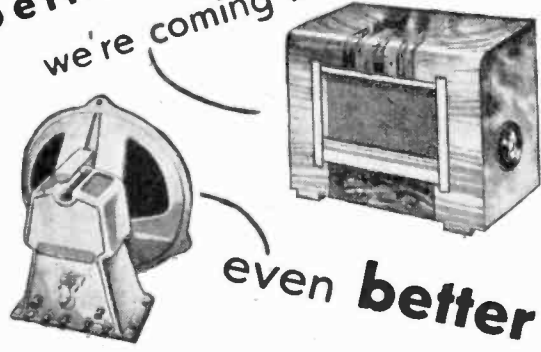

even **better**

**WHITELEY ELECTRICAL RADIO CO. LTD. • MANSFIELD • NOTTS**



**5 mmf/ft**

NEW LOW LEVELS in capacity and attenuation of CO-AX Cables mean new possibilities in electronic equipment design both for the war effort and for the post-war electronic age.

Write for characteristics

**BASICALLY BETTER  
 AIR-SPACED**

**CO-AX LOW LOSS CABLES**  
**TRANSRADIO LTD. 16 THE HIGHWAY • BEACONSFIELD • 4-BUCKS.**



Doing vital service amidst the battle smoke

**DAGENITE AND  
 PERTRIX  
 BATTERIES**

D11C144

Sales Concessionaires:  
**HOLSUN BATTERIES LIMITED, 137 Victoria St., London, S.W.1**

**When**

**you take off your battle-dress**





... L & P will be waiting to help re-establish and re-stock, bona-fide dealers.

You are cordially invited to contact us on your demobilisation or discharge. Meanwhile a line from you as to where you hope to situate your premises will be welcomed.

**LONDON & PROVINCIAL FACTORS LTD.**  
 "Wanie" House, Aylmer Parade, East Finchley, London, N.2. - Telephone MOUNTview 9425/7.

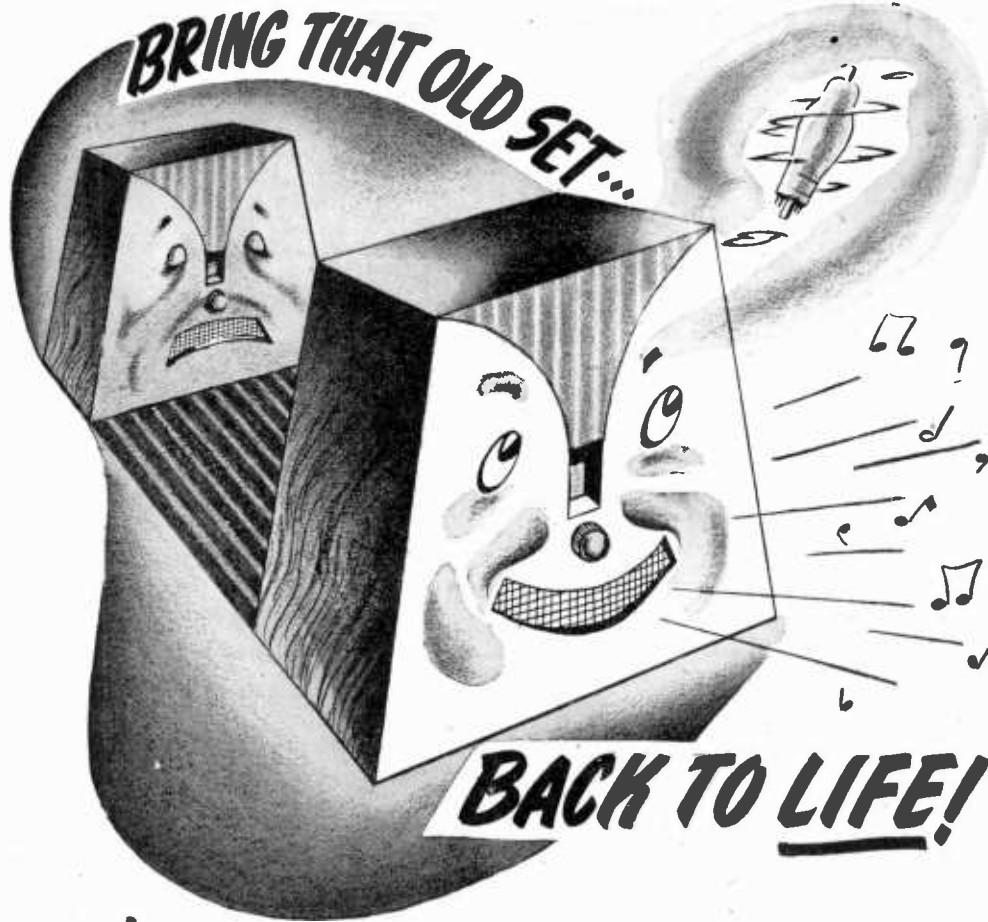



If your set is on the shelf because of valve trouble, you will be pleased to hear that in spite of heavy service demands the Government is releasing more MAZDA Valves for civilian radios.

New Mazda Valves in your old set, whether it is completely out of action or only showing symptoms of wear and tear,

will make all the difference.

Your Dealer has details of all available types of MAZDA Valves, but in case of difficulty please write to us..

# MAZDA RADIO VALVES

## M.R. SUPPLIES

are able to supply immediately from present stock the following first-class and brand new **RADIO, ELECTRICAL AND TECHNICAL EQUIPMENT**. All prices nett. **BATTERY CHARGING EQUIPMENT**, comprising S.T.C. Metal Rectifier for 6-amp. delivery and associated Mains Transformer, primary 200/240 v. and secondary tapped for 6 and 12 v. charging at full 6 amps., the pair **£4.19.0** (carr. 2/6). Here is your opportunity! Suitable Rheostat, if required (4 ohms 5 amps., 10 ohms 3 amps. or 50 ohms 1.5 amp. Please state which). 25/-. Other ratings of **METAL RECTIFIERS** in stock, 12 v. 1.5 amp., 12/6; 12 v. 10 amp., 52/6.

**STEP-DOWN MAINS TRANSFORMERS**, prim. 200/240 v., sec. 7, 11 and 15 v. at 2 amps., 20/-. Prim. 200/240 v., sec. 22 v. 2 amps., 18/6. Prim. 200/240 v., sec. 5, 12 and 17 v. at 6 amps., 49/6.

**SLIDING RESISTANCES** (additional to above), 100 ohms 1 amp., 200 ohms 0.7 amp., and 400 ohms 0.5 amp., any one, 25/-. Also 225 ohms 1 amp., 35/-.  
**STAGE DIMMERS**, controlling stated load from full-bright to black-out. With screw motion and handwheel. 1,000 watts, **£8.17.6**; 1,500 watts, **£8.8.0**. (We cannot despatch.)

**LONDEX RELAYS**. 230 volt A.C. (2 watt) coil with 3-pole change-over silver contact switch, 6 amps. at 230 v., 45/-.  
**MILLIAMMETERS**, by prominent London maker. High-grade precision moving coil instruments, reading 0-1 m.a., the ideal basis for combined instrument. Flush mtg., 2½ inch, 52/6. 3½ inch, 67/6.

**CENTRALAB VOLUME CONTROLS**, useful range. Less switch. 1,000, 3,000, 10,000, 50,000, 100,000 and 500,000 ohms, any one, 3/11 (45/- doz.). With switch (few only), 250,000 ohms and 1 megohm only, 6/- each.

**HEAVY DUTY OUTPUT TRANSFORMERS**. Handling 25 watts A.C. at high fidelity. Tapped prim. and sec. with P.P. and providing 11 ratios from 12/1 to 75/1. Finished brackets and terminal panels, weight approx. 10 lbs. There is no better O/T. 59/6. (Despatch 2/-)

**VITAVOX 12-inch P.M. SPEAKERS**. Model K12/10, handling 10 watts. 15 ohms coil, Ticonal high-flux magnet. The speaker for the high-fidelity enthusiast. £7. (Carr. 0/-)

**GRAMPIAN MOVING COIL MICROPHONES**. In square suspension frame with mounting boss, **£4.17.6**. Also small supply of same make Senior model for highest quality work. Handsome all-plated instrument with local on-off switch and quick release, **£7.15.0**. **ROTHERMEL PIEZO-CRYSTAL MICROPHONES**. The original and famous D.104 in plated housing with suspension rings and 8ft. screened cable, **£5.5.0**. **MICROPHONE STANDS**, all chrom. Table, extending, 29/6. Floor, collapsible, 45/6. Cradle for D.104 only, 8/- extra.

**MINIATURE P.C. MICROPHONES** (Rothermel). Deaf-aid type 1¼in. dia. Insert type, with no front grille, 29/6.

**HEADPHONES**, new light-weight model, with headband, 4,000 ohms, 21/6 pr.  
**G.E.C. PROJECTOR SPEAKERS**, with 42-inch all-metal Horn and P.M. Unit (15 ohms). 10 watt, **£10.5.0**. 12 watt (Type A Unit), **£12**. (Carr. 7/6)

**ELECTRIC ARC WELDERS** for 6 or 12 v. battery. 15in. long with generous length of tough rubber cable with clip, two carbon electrodes, 35/-. (Spare electrodes, 1/- each.)

**S.T.C. TOGGLE PRESSES**. Double-acting, precise tool for pressing work in many trades. Both models again in stock. Senior (1½ tons pressure), **£30**. Minor (0.8 ton pressure), **£23**, ex this address.

Please include sufficient for packing/postage, where not stated.

**M.R. SUPPLIES, 68, New Oxford Street, London, W.C.1**

(Telephone: MUSeum 2958)



It is a fact that although VITAVOX K12/10 and K12/20 P.M. Speakers are not available in unlimited quantities, their quality is such that they are well worth waiting for.

It is a fact too that all specification figures are actual and not nominal.

**VITAVOX LIMITED,**  
WESTMORELAND  
RD., LONDON, N.W.9.  
Phone Colindale 8671/3

For **Reliability**

Just **TRIX**

Quality **SOUND** Equipment

THERE ARE TRIX AMPLIFIERS FROM 5 TO 500 WATTS FOR PRIORITY WORK

**THE TRIX ELECTRICAL CO. LTD.**  
1-5, MAPLE PLACE, TOTTENHAM CT. RD.  
LONDON, W.1.  
Tele. MUSEUM: 5817 Grams & Cables: TRIXADIO, WESDO, LONDON.

**TENAPLAX**

Co-axial Cable

represents the very latest scientific achievements applied to High-Frequency Engineering.

We shall be pleased to offer a correctly designed cable to potential users of High-Frequency Equipment on receipt of answers to the following questions:

1. CHARACTERISTIC IMPEDANCE.
2. CAPACITY PER FOOT.
3. IF FOR TRANSMISSION STATE WATTAGE & FREQUENCY

**TENAPLAS LTD., 7 PARK LANE, LONDON, W.1**



# RAYMART COILS



RD4 low-loss dielectric material is used exclusively in "Raymart" coils.

4-Pin			Price
Type CA.	11 to 25 metres	...	2/6
" CB.	20 to 45 "	...	2/6
" CC.	44 to 100 "	...	2/9
" CD.	80 to 180 "	...	2/9
6-Pin			Price
Type CA6.	11 to 25 metres	...	2/9
" CB6.	20 to 45 "	...	2/9
" CC6.	44 to 100 "	...	3/-
" CD6.	80 to 180 "	...	3/-
" CE6.	110 to 250 "	...	3/3

## RAYMART COIL FORMERS

4, 6-and 7-pin are also available. Full details on request.

**RAYMART MICRO-VARIABLE CONDENSERS**  
Models available: Standard (VCX); Midget (MCX) Series Condensers, etc. Further details and prices supplied on application.

Please include postage on orders under 5/- in value.

# RAYMART

CRAFT A CREED

48 HOLLOWAY HEAD, BIRMINGHAM, 1

Telephone: Midland 3254

# CELESTION

## VALVEHOLDERS LOUDSPEAKERS

Celestion Limited  
Kingston-upon-Thames  
Telephone: KINGSTON 5656-7-8

# CASE

by

## IMHOF'S

ESTABLISHED 1845

THE HALLMARK OF A GOOD INSTRUMENT

If you are inclined to the view that your instruments deserve a case that is better built and of more attractive and functional design, or you build equipment that needs precision sheet metal work, you will be interested to have this catalogue. A penny stamp and the request on your business letterhead will bring it you.

ALFRED IMHOF LTD. 112-116 NEW OXFORD STREET, LONDON, W.C.1. MUSEUM 5944

# Out in Front!

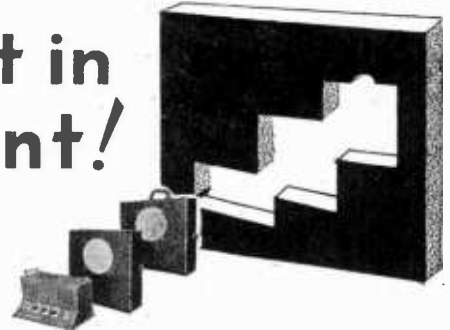

R. S. Sound Equipment is right out in front. In design ... in performance ... in reliability, the "Universal Fifteen" for example, is in a class by itself. A truly portable "portable equipment," it operates on any voltage from 200 to 250 AC or DC, and one that you will be as proud to own as we are to make. Fullest information will gladly be sent to you on request.

# R.S.

A 'BUY' WORD IN

*Amplifiers*

R.S. Amplifiers Ltd., 2-4 Highfield Road, Shepperton, Mdx.  
Telephone: Walton-on-Thames 1019



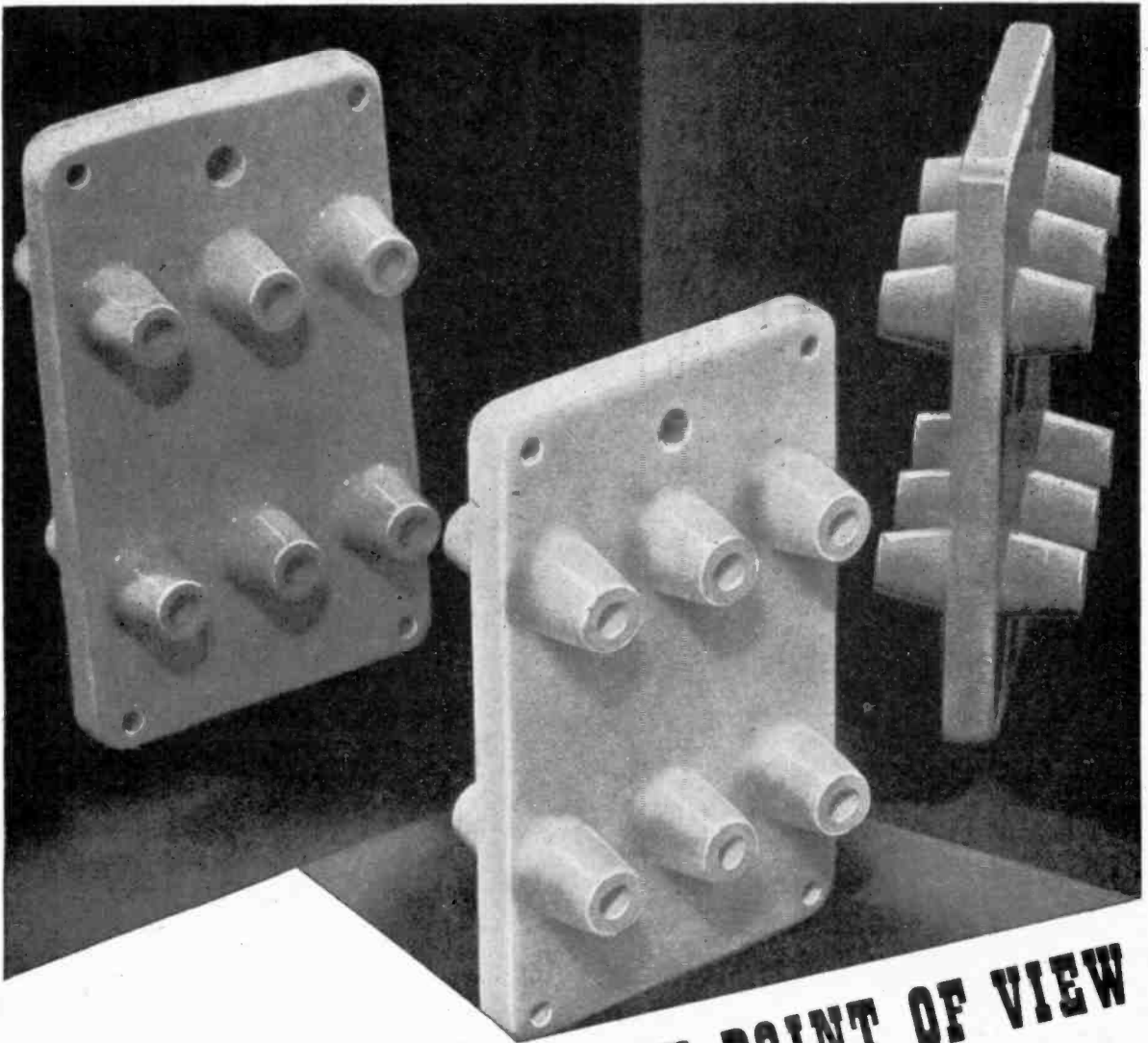

**FROM EVERY POINT OF VIEW**

Frequentite is the most suitable material for all high frequency applications. Ten years ago we introduced the first British-made low loss ceramic, and consultation with us before finalising the design of new components is a wise precaution.



**STEATITE & PORCELAIN PRODUCTS LTD.**

Head Office: Stourport-on-Severn, Worcester.

Telephone: Stourport 111.

Telegrams: Steatain, Stourport.

SP20

# MINIATURE or MIDGET



We specialise  
in their  
manufacture

## HIVAC

THE SCIENTIFIC  
VALVE

BRITISH MADE

*Originators,  
designers & manufacturers of Midget Valves*

HIVAC LIMITED. Greenhill Crescent, Harrow on the Hill, Middx. Phone: HARROW 0895



# Stabilistor

THE  
**WESTINGHOUSE**

## A.C. VOLTAGE STABILISER

- ★ Undistorted output wave.
- ★ Constant output with mains changes of  $\pm 15\%$ .
- ★ Only one equipment needed to stabilise the supply to an entire measurements laboratory or recording installation, etc.
- ★ Standard sizes from 80-1,200 V.A. output.

Rapid response to mains or load changes.  
Constant output from zero to full load.

Write for literature to Dept. W.W.,  
**WESTINGHOUSE BRAKE & SIGNAL CO., LTD.,**  
Pew Hill House - Chippenham - Wilts.



It isn't . . . . . Isn't what!  
Isn't a watt!  
It's the c.g.s. unit of energy.

### WHAT'S "ERG"?

ERG is the trade mark identifying a line of products that will be available when we've finished the biggest job of all.

**ERG RESISTORS LTD.**  
1021a, FINCHLEY ROAD, LONDON, N.W.11  
PHONE: SPEEDWELL 6967



## WALTER SWITCHES ARE MADE FOR



# WALTER

INSTRUMENTS. LTD.

Earls Court Exhibition Buildings, Earls Court, London, S.W. 5  
FULHAM 6192

## SOUND EQUIPMENT

*real  
Sales with Service*

Personal consultation and advice is freely given on the combination of equipment best suited to your particular need. Any make demonstrated without obligation.

- 12" P.M. SPEAKERS with Ticonal Magnets in stock.

# R.G. JONES

OF MORDEN

MORDEN PARK SOUND STUDIOS  
London Road • Morden • Surrey  
Phone: MITcham 3668

## LONDEX for RELAYS



for A.C. and D.C.  
2 VA Coil consumption from 2 to 600 volts and tested to 2000 volts, Aerial Changeover Relays, Mercury Relays, Measuring Relays and Time Delay Relays.

Multiple contact Relay LF.

Ask for leaflet 205/WW

## LONDEX LTD

MANUFACTURERS OF RELAYS  
207-209, BAKER STREET, LONDON, W.1

## BERRY'S

(SHORT-WAVE) LTD.

### A MOST COMPLETE LIST "W" of RADIO & ELECTRONIC EQUIPMENT

will be sent on receipt of stamped envelope.

25, HIGH HOLBORN, LONDON, W.C.1  
Telephone: HOLborn 6231

# BEACONS OF RELIABILITY

# EDDYSTONE

# Radio

# PRODUCTS

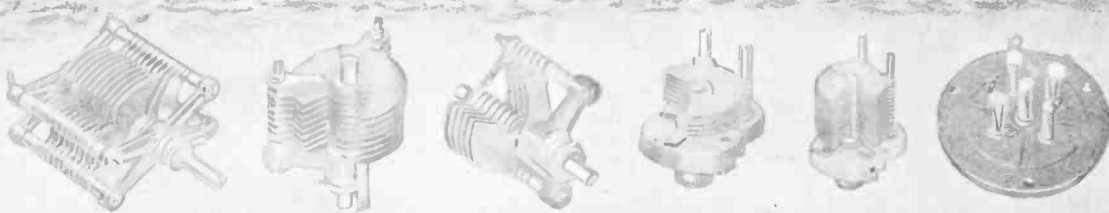

MANUFACTURED BY  
**STRATTON & CO., LTD.** EDDYSTONE WORKS **BIRMINGHAM.**  
 TELEPHONE: PRIORITY 2231 CABLES: 'STRATNOID' BIRMINGHAM.  
 LONDON AGENTS:-  
**WEBB'S RADIO.** 14, SOHO STREET, OXFORD STREET, LONDON. W. 1.  
 TELEPHONE: GERRARD 2089



# Exide

## IN PARLIAMENT . . . . .

### In the House of Commons :

*Mr. EVELYN WALKDEN asked the President of the Board of Trade why 120-volt Exide Batteries which are sold at 11s. 1d. are in short supply and other 120-volt batteries of less reliable make, and sold at 15s. 6d., only are available . . .*

Mr. DALTON : Wireless batteries are now in short supply, owing to the heavy demands of the Services, and it is necessary, therefore, to make use of the output, although small, of the higher cost producers. Prices are controlled under the Price of Goods Act, 1939, and those charged for both classes of battery referred to by my Hon. Friend have been investigated and approved by the Central Price Regulation Committee.

*Mr. WALKDEN : While appreciating what my Right Hon. Friend has said, is he not aware that batteries are used largely by people in small homesteads who cannot understand why good batteries cannot be obtained while there is a plentiful supply of inferior ones. . . ?*

Mr. DALTON : I am very anxious to get a fair distribution of whatever supplies there are, but the best batteries are required for the Services in a very great and increasing quantity . . .

(Extracts from Hansard, Jan. 16)

THE CHLORIDE ELECTRICAL STORAGE COMPANY LIMITED

GROSVENOR GARDENS HOUSE · LONDON · SW1



# Wireless World

Radio and Electronics

35th YEAR OF PUBLICATION

## MAY 1945

Proprietors :  
LILFFE & SONS LTD.

Managing Editor :  
HUGH S. POCOCK.  
M.I.E.E.

Editor :  
H. F. SMITH

Editorial, Advertising  
and Publishing Offices:

DORSET HOUSE,  
STAMFORD STREET,  
LONDON, S.E.1.

Telephone :  
Waterloo 3333 (35 lines).

Telegrams :  
"Ethaworld, Sedist, London."



PUBLISHED  
MONTHLY

Price : 1/6

(Publication date 26th  
of preceding month)

Subscription Rate :  
Home and Abroad  
20/- per annum.

MONTHLY COMMENTARY .. .. .	129
TELEVISION COMMITTEE'S REPORT. By R. W. Hallows .. .. .	130
FREQUENCY ALLOCATION. By Dr. R. L. Smith-Rose .. .. .	133
ARMY SET—TYPE 76 .. .. .	137
VALVE VECTORS. By Dr. K. R. Sturley .. .. .	140
U.S. FREQUENCY PROPOSALS .. .. .	142
UNBIASED. By Free Grid .. .. .	144
RADIO SPECTROSCOPY. By Thomas Roddam .. .. .	145
LETTERS TO THE EDITOR .. .. .	149
WORLD OF WIRELESS .. .. .	151
NEWS IN ENGLISH FROM ABROAD .. .. .	153
COLOUR TELEVISION .. .. .	154
RANDOM RADIATIONS. By "Diallist" .. .. .	156
RECENT INVENTIONS .. .. .	158

Branch Offices :

COVENTRY :  
8-10, Corporation Street.  
Telephone : Coventry 5210.

Telegrams :  
"Autocar, Coventry."

BIRMINGHAM :  
Guildhall Buildings,  
Navigation Street, 2.

Telephone :  
Midland 2971 (5 lines).  
Telegrams :  
"Autopress, Birmingham."

MANCHESTER :  
260, Deansgate, 3.  
Telephone :  
Blackfriars 4412 (4 lines).  
Telegrams :  
"Iliffe, Manchester."

GLASGOW :  
26B, Renfield Street, C.2.  
Telephone : Central 4857.  
Telegrams : "Iliffe, Glasgow."



As many of the circuits and apparatus described in these pages are covered by patents, readers are advised, before making use of them, to satisfy themselves that they would not be infringing patents.

## VIBRATORS • TRANSFORMERS • SWITCHES • COILS

'Stratosil Sealed'  
for EFFICIENCY

Wearite "Stratosil Sealed" Vibrators operate efficiently and with the utmost reliability in all situations irrespective of climatic conditions. They embody many features exclusive to this type of component and are available just now only for purposes directly connected with the war effort.

**STRATOSIL**  
Sealed VIBRATORS

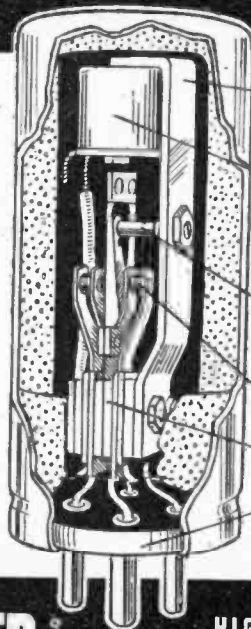

All steel construction—even to the rivets—ensuring uniform expansion under extremes of temperature.

Reed driving coil—wound on a bakelite moulded bobbin to meet all climatic conditions.

Metal can, sponge rubber lined—Acoustically and electrically shielding the Vibrator.

Driving contact of non-tarnishable precious metal—ensuring starting under the lightest of pressures and voltages.

Contacts ground almost to optical limits.

Stack assembly. Mica and steel only are used.

Base sealed by the WEARITE STRATOSIL process.

**WRIGHT & WEAIRE LTD**



HIGH RD. TOTTENHAM N.17  
TELEPHONE: TOTTENHAM 3847

# *The* **MULLARD** *all-glass technique*

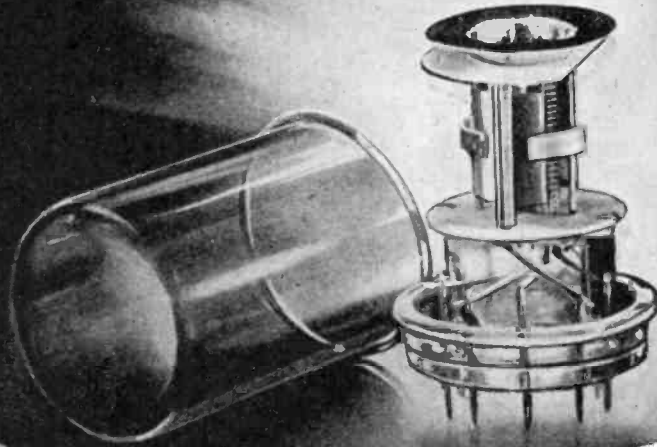

A  
DEVELOPMENT  
OF THE  
MULLARD  
LABORATORIES

By a complete departure from the conventional form of valve construction, Mullard have effectively reduced the losses due to H.F. resistance, inductance and capacity effects within the valve itself and in the leads coming from the electrodes. The all-glass technique makes use of an almost flat circular glass pressing for the base of the valve, into which short pins are sealed, the electrodes being welded directly to the pins. By thus reducing the length of the lead-out connections, considerably improved efficiency at the higher radio frequencies has been achieved.

# Wireless World

Radio and Electronics

Vol. LI. No. 5

MAY 1945

Price 1s. 6d.

## Monthly Commentary

### Television Psychology

So far, there have been few adverse criticisms of the Television Committee's Report, summarised in this journal last month. Indeed, it has been the subject of surprisingly little serious discussion, though several well-deserved tributes have been paid to the painstaking and thorough manner in which the members have carried out their difficult task. There is much that is admirable in the Report, but we think it fails to take into account the psychological reactions of the average potential viewer, on whose attitude will ultimately depend the success or failure of British television. In particular, he has heard so much of wartime developments that he is unlikely to be more than lukewarm towards the restarted pre-war system, especially when there is a promise of "better television round the corner." There will be every temptation to delay the installing of a receiver. Promises that the 405-line service will be retained for a period of years, in parallel with transmissions of higher definition, will do little to allay feelings of uncertainty and fears of obsolescence. A secondary matter, also largely psychological, is the size of the television viewing screen, which was often compared, perhaps subconsciously and certainly unjustifiably, with the larger screen of the cinema.

These and similar questions must be studied most intensively by all concerned with the future well-being of television. Most emphatically, the set-up of our post-war service, which will depend for its success on the number of patrons it can attract, cannot be decided on a severely rational basis of technical standards or programme composition. Less tangible factors are of at least equal importance. For instance, we should try to learn why so few receivers were sold between 1936 and 1939. (The generally accepted figure is only 18,500). Many reasons have been given; at present one guess seems almost as good as another. Fear of obsolescence was undoubtedly one cause. "Television is still in its infancy; it is certain to become better and cheaper before long." Again, it is doubtful if television was publicised to the best advantage; did all those millions to whom the

service was in fact available fully realise that it was a practical possibility for them?

*Wireless World* has always urged the need for re-establishing television with the least possible delay, and inclines more strongly than ever to the view that a new start should be made with a standard of definition involving no radical departure from well-tried technique, either in transmission or receiver design. But, within that limitation, definition should be the highest that can be achieved. Let us concentrate on that, without too many problematical "1,000-line" distractions.

Elsewhere in this issue a contributor examines the Report in detail, and rejects the re-establishment of the 405-line pre-war service as anything but a temporary measure. We hope that readers will give us their view on this important matter.

♦ ♦ ♦

### The Technical Press

During the war all specialised journals have suffered under severe restrictions, particularly in the way of paper rationing. Supplies of paper have been cut to one-fifth of pre-war consumption, and quality has deteriorated seriously. Believing that the time has now come when we can perform an essential social function in paving the way for post-war reconstruction, the Council of the Trade and Technical Press, representing more than 200 journals, has presented a joint case to the authorities. This is in the form of a Memorandum, drawn up by the Council under the chairmanship of Roland E. Dangerfield, pleading for immediate relaxation of the main handicaps under which we have laboured. It is pointed out that the specialised Press serves as a forum for discussion of post-war problems by industrialists and technicians, many of whom have lost touch, during the war years, with their normal peacetime activities. In order that the diverse interests of readers can be treated adequately, and the case of British industry can be worthily presented both at home and abroad, we need more and better paper and printing facilities. In addition, the authorities are urged to release information on wartime technical developments at the earliest possible moment that security will allow.

# TELEVISION COMMITTEE'S REPORT

## Are They Flogging a Dead Horse ?

NO one can read the Report of the Television Committee\* without being impressed by two things. The first of these is the amount of hard work done by Lord Hankey and his fellow members, both in the examination of witnesses and in coming to the conclusions which the Report embodies. The second is the complete sincerity of the Report: it represents the reasoned beliefs of a body of men who have devoted themselves unselfishly and untiringly to the task which was assigned to them. But no committee, whatever the subject of its enquiry and whatever its terms of reference, can expect that its findings and recommendations will meet with a hundred per cent. agreement when they are published. As one who has the future of British television very much at heart, I confess that I am uneasy about the present Report, and I find that my misgivings are shared by a good many of those with whom I have discussed it.

### The Witnesses

To begin with, I cannot help feeling that Lord Hankey's committee made one cardinal error in selecting the witnesses whom they examined. These witnesses consisted (Report, Appendix 1, p. 22) of representatives of the following organisations: the General Electric Company, the Marconi-E.M.I. Television Company, Scophony Limited, Standard Telephones and Cables, the Board of Trade, the B.B.C., the British Film Producers' Association, the Ministry of Education, the Radio Industry Council, and the Cinema Renters', Exhibitors' and Producers' Joint Committee. The only other witness was J. L. Baird. In a word, the witnesses consisted entirely of "transmitters" rather than "receivers," if I may so put it. All were interested in the manufacture of televisions, in the marketing of televisions, or in what could be put over by television. No one appears to have been called

By R. W. HALLOWS,  
M.A., A.M.I.E.E.

by the Committee to give them the view of the buyer—the owner or would-be owner of the television receiver—the experiences of those who had such apparatus in their homes before the war or the feelings of the amateur enthusiast who is interested in both the technical and the entertainment aspects of television. And by not examining witnesses of these kinds the Committee were, I believe, led to form certain decisions which might have the effect of retarding very seriously the development of television in this country when the war is over.

Fortunately, however, the conclusions and recommendations contained in the Report are not final: the Committee is emphatic that a new advisory committee should be appointed by the Government and that this body should have a very large say in all matters affecting television in post-war days. The advisory committee, one gathers, will not be bound hand and foot by the Hankey Committee's recommendations. There is, therefore, still time for the adoption of a policy which will lead to rapid progress and to Britain's retention of the lead in the television field. I am convinced that the reverse of both these things would be inevitable were the recommendations of the Report carried out as they stand.

### A Poor Start

Let us see first of all what reasons the Committee accepts for television's failure to become a popular hobby in the years before the war. If those reasons are the right ones, well and good: once you really know why a promising thing does not achieve success at first you are well on the way to making a success of it eventually, for you understand what to do and what to avoid in the future. But *are* the reasons given in the Report the real reasons why in its first 2½ years

television crawled into popular favour instead of advancing at the expected gallop? Here they are:

"By 1939 the service had reached a high standard, the programme technique had made great progress, and the result was a service of considerable entertainment value. The number of television receivers in use by the public did not, however, rise appreciably above 20,000. This was ascribed *inter alia* to the cost of the sets (£20 to £75), the belief that the price would soon fall and the fear of obsolescence. The restriction of the service to the London area no doubt gave rise to the impression that the service was still in the experimental stage. Nevertheless the demand for the extension of the television service to the provinces became insistent. It was urged in Parliament, in the Press, and by the Radio Industry."<sup>1</sup>

There is also a mention of the fact that "a considerable number of complaints were made of electrical interference with the reception of pre-war television programmes."<sup>2</sup>

### Fear of Obsolescence

I accept without question that 20,000 television receivers had left the factories, but I fancy that the number actually in private ownership was a good deal below that figure when the war broke out. And emphatically I do not believe that the price of £20-£75 had much to do with it. The area covered by the Alexandra Palace transmissions contains, one understands, between a quarter and a third of the entire population of England and Wales; no one would suggest that less than 20,000 radio receiving sets and radiograms at prices of £20 upwards were sold there in 1937, 1938 and 1939. And many of the quite moderately priced television receivers were also "all-wave" radio receivers or even radiograms as well. If people believed before the war that the prices of televisions would

\* "Report of the Television Committee, 1943": H.M. Stationery Office, 1945. 6d.

soon fall, they still have that belief, for it has been fostered (if I may say so without offence to my many good friends in the wireless industry) by the pronouncements of prominent members of the industry itself, and so far as one can see there is nothing to prevent them from holding it indefinitely! Nor can I accept fear of obsolescence or any feeling that transmissions were still experimental as root causes of the public's slowness to invest in television receivers. There certainly was a very definite demand for the extension of the Alexandra Palace service to the provinces, and that could hardly have been so strong had there been widespread apprehension of this kind.

This much I can say: I have talked television certainty with scores and probably with hundreds of people of all kinds and very few indeed of those who did not possess television receivers gave any of the reasons accepted by the Committee. What they did tell me was that they were not satisfied that the pre-war service was providing adequate entertainment, save on occasions when there was some big sporting or

nary radio sets and radiograms.

With the programme side of television I dealt at some length in the columns of *Wireless World* last year.<sup>3</sup> The point I made then was that we knew now *how* to televise, but had not yet discovered *what* to televise in order to provide good entertainment day in, day out. Some suggestions were made which the powers that be may or may not regard as being of value. The means of allaying the not unnatural fear of the cost of "retubing" a television receiver or of revalving apparatus containing a large number of valves rests with the industry. May I emphasise the fact that people are not nearly so frightened of a fairly high initial outlay as of the possibility of having to spend on replacements at a later date more than the instrument is then worth?

#### Size of Screen

A very important reason that has deterred listeners from becoming viewers is their dislike of the small screen. Many who have discussed the matter with me have drawn comparisons between the televisor and the home

screen, say, 30 inches by 20, and definition approaching that of the home movie projector, there would be enthusiasm where there is now lukewarmness or even antipathy.

Now, 405-line television may be reproduced on big screens, as it was before the war by the Scophony process, but, the bigger the screen, the more obvious are the shortcomings due to poor definition. That fact was recognised by the Committee, who regarded 405-line transmission as suitable for a picture no bigger than 8in. x 10in.<sup>4</sup> Yet this same Committee recommends the extension of the 405-line system to six provincial centres after the war<sup>5</sup> at a capital cost of 1½ million pounds.<sup>6</sup> It recommends that an improved system, of possibly 1,000 lines, be introduced as soon as possible, and that for some considerable time the new and the old systems should run side by side.<sup>7</sup>

#### Second Best

What is the point of extending the 405-line system to the provinces if something better is to be introduced at no distant date? Is not the spending of a million and a half of good money on such a scheme something very like sheer waste? Why should people in the provinces rush to buy 405-line television receivers when the millions in the London service area would not do so? Even though they have the assurance that the 405-line transmissions will be continued for years after the arrival of the improved system, will there be any real inducement to people to buy such sets? I think not, for very few are content to have something that is notoriously a poor second-best. My own belief is that, were the money spent and the six extensions made, the result would be a ghastly flop; would-be purchasers would wait for the new and better system, particularly if their dreams of ever-falling prices led them to believe that the 1,000-line television receiver of the not-far-distant future would cost no more (perhaps even less!) than the 405-line instrument then offered.

And there is something else to be considered. Again and again in the Report the Committee stresses the importance of Britain retaining the world lead in the

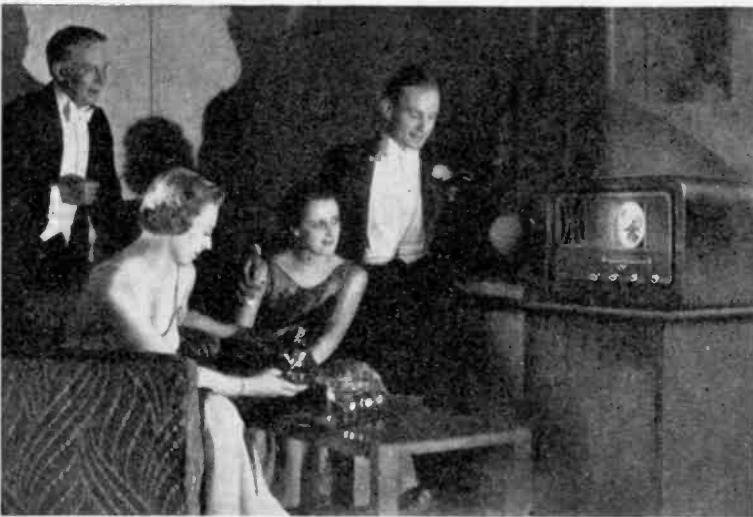

"A very important reason that has deterred listeners from becoming viewers is their dislike of the small screen."

news event to broadcast; that the viewing screen was too small for their liking; that they were apprehensive of the possibly staggering cost of CRT and valve replacements and that, on the whole, they did not feel that they were missing much by sticking to ordi-

cinematograph. The latter, they say, is fine. A whole roomful of people can watch the moving pictures in comfort; you don't have to peer; there is no need to sit or stand tightly packed right opposite the middle of the screen. In fact, given a television viewing



**Television Committee's Report** — field of television. What will the rest of the world think of us if, after the war, we expend money, materials and technical ability in making nation-wide an admittedly inferior television system? By the time that the projected six provincial centres were

"Television and the cinema are likely to be closely bound together in the future." This illustration is reproduced from a photograph taken on Feb. 23, 1939, when two cinemas at Marble Arch, London, showed B.B.C.'s television broadcast of the Boon - Danahar boxing match.



all the technical brain power that can be made available be devoted to research and to the rapid development of high-definition tele-

forward some years ago in *Wireless World*.<sup>10</sup> That partnership can never come properly into being with a 405-line system. When it does come its consequences are likely to be so important that we should do all that we can to hasten the day.

From almost every point of view, then, it behoves us to cease as soon as may be from flogging the almost dead horse of 405-line television and to put our money on an altogether better and very much alive animal, which will prove a winner, surely.

#### REFERENCES

- (1) Report §5, p.4. (2) Report §39, p.11. (3) "Television Survey," *Wireless World*, June 1944. (4) Report §14, p. 6. (5) Report §28, p. 9. (6) Report §65, p. 16. (7) Report §29, p. 9. (8) Report §52 *et seq.*, p. 18. (9) Report §31 *et seq.*, p. 10. (10) "A Partnership with the Cinema," *Wireless World*, 9th March, 1939.

#### HEADS OR HANDS ?

AT a recent discussion meeting of the Radio Section of the Institution of Electrical Engineers on apprenticeship and training, the opinion was expressed that the "incoherent growth and newness" of radio precluded attempts to establish as yet any rigidly defined methods of training or grading of technical workers. Many speakers stressed the point that the industry has depended largely on ex-amateurs, and the present tendency of the industry to discourage the amateur was criticised as unwise.

It was widely thought that far too much stress has been laid in the past on the need for specialised training in "craftsmanship"; that term, as generally understood, tended to emphasise the need for a degree of manual dexterity that did not in fact exist in the radio industry, except in rather exceptional cases. In most radio production work there was little scope for craftsmen with a specifically radio training. In general, "heads were more important than hands." One speaker contended that a purely radio training might even be inimical to the interests of the manual worker, as it would narrow his field of employment.

Much sympathetic consideration was shown for the difficulties of recruits to radio, which was thought to attract an extremely good type of entrant. Most speakers urged that young entrants should have every opportunity to change from one grade to another, according to their abilities. It was emphatically stated that the student-apprentice should not be expected to undergo vocational training outside normal working hours.

erected we should almost certainly have in being not the best but the worst television system of the great countries. The Committee is fully alive to the importance of our building up a great export trade in television gear;<sup>8</sup> how can we hope to do anything of the kind if other countries believe—as believe they will, no matter what we say about the future—that we have pinned our faith to 405 lines?

Surely, by far the sounder course would be to regard our pre-war 405-line system as obsolescent, if not, indeed, obsolete, and to decide firmly to spend no more money in developing it. The Alexandra Palace station must certainly be brought back into action at the earliest possible moment after the end of the war. By so doing we shall keep faith with those who now own television receivers, and we shall give the entertainments departments of the B.B.C. full opportunities of developing the new lines of vision broadcasting that are essential to ultimate success. Meantime, let all the money and

vision. As soon as a system has been approved, let the first high-definition station (to work on the standard to be finally adopted) be erected at Birmingham or some other chosen provincial centre. London had the first television service; it is the turn of the provinces to be first with high definition. The new London station must be one of the earliest erected after this on account of the vast population of the area served by it. The moment this station is working satisfactorily, the 405-line system should be scrapped, lock, stock and barrel.

If we devote our money and energy to a first-rate system and do not squander either on what is already out of date, the new television service might well come into being far sooner than the compilers of the Report envisage. There would then be no doubt about our retaining our lead and export prospects should be good.

Lastly, the Report recognises that television and the cinema are likely to be closely bound together in the future.<sup>9</sup> I have long held this view, and first put it

# FREQUENCY ALLOCATION

## Needs of Long-distance Communication Services

By R. L. SMITH-ROSE,

D.Sc., Ph.D., D.I.C., A.R.C.S., M.I.E.E.,  
F.I.R.E.

(National Physical Laboratory)

THE present allocation of radio-frequency channels for various communication purposes, excluding any effects brought about by the war, was settled by the International Conference at Cairo in 1938. The revised regulations there drawn up and agreed to by the representatives of sixty-five nations, provided for the allocation of radio frequencies over the whole spectrum from 10 kc/s to 200 Mc/s. This range of frequencies covered not only the needs of radio communication but also other applications, such as navigational aids and radio meteorological soundings, that had already attained a certain stage of practical development. The present article is limited to a discussion of the needs of radio communication over distances of 500 miles and upwards, as they would appear to be in the immediate post-war period.

For communication over these distances the appropriate frequency bands would appear to be broadly 10 to 300 kc/s and 3 to 30 Mc/s. While it is known that signals on frequencies outside these bands are on occasions received at distances in excess of 1,000 miles at specially favourable times or seasons, these conditions cannot be considered as suitable for the operation of a communication service at a usefully high load factor. In particular, the intermediate region from 300 to 3,000 kc/s is uneconomical for ranges exceeding 1,000 miles, since the attenuation of the ground waves and the absorption of the ionospheric waves are both detrimental to reliable communication over such distances.

The justification for selecting the above frequency bands is based upon the present state of our knowledge of the propagation of radio waves around the surface of the earth and through the ionosphere. This knowledge is now considerably in advance of that available when the current distribution of frequencies was drawn up by the Conference at

Cairo in 1938, and it is to be expected that any revision of the allocations will have due regard to the known suitability of the various frequencies from a wave propagation standpoint.

**Frequencies between 10 and 300kc/s.**—At the low frequency end of the first band (10-300 kc/s), the experience gained with the operation of a station such as Rugby on a frequency of 16 kc/s has shown that only by using a low frequency of this order can a virtually continuous telegraphic service, necessarily of a broadcast nature, be maintained with ships and other receiving stations in all parts of the world. The opinion expressed at a meeting\* of the Institution of Electrical Engineers in 1926, that no more super-high-power stations would be built for long-distance communication has proved wrong. Thus there is justification for continuing the use of the band 10 to 100 kc/s for fixed stations erected for the purpose of maintaining communication in various directions at ranges from 500 miles and upwards. The upper end of this band and continuing up to about 300 kc/s is usefully confined to those services operating entirely over sea, such as from coastal stations to ships and aircraft, since in this way the maximum use can be made of the reliable ground-wave range. While at least one radio-telephone service has been operated successfully on a carrier frequency near 60 kc/s, it is perhaps relevant to enquire whether the frequency band, about 3 kc/s wide, required for such a service could not be more usefully and economically employed for high-speed telegraphic purposes.

**Frequencies between 3 and 30 Mc/s: Ionospheric Conditions.**

—When we turn to the second frequency band of 3 to 30 Mc/s it is by no means such a simple matter to suggest allocations; but it is suggested that it will be useful to take note of the conditions imposed by the ionosphere on the possibility or otherwise of maintaining virtually continuous communication conditions over the assigned path, and then compare the results of such a study with the experience obtained in the operation of long-distance radio traffic routes during the last decade or so. The results obtained from measurements of the reflection of waves from the ionosphere reveal several facts of which it is essential to take account in planning the frequencies necessary for communication over various distances and at various times and seasons.

The highest frequency at which waves are reflected from the ionosphere over a particular path varies in a ratio of between two and three to one from day to night in the winter, and in a somewhat smaller ratio in the summer. The change in frequency from maximum to minimum of the sunspot cycle, some five to six years, is also about two to one, all other conditions remaining the same.

Apart from the fact that waves in this high frequency band are transmitted efficiently through the ionosphere, a feature which is of great practical importance in radio communication is that the wavelengths involved (10 to 100 metres) are very suitable for the use of highly directive antenna array systems, which both reduce the signal interference conditions and improve the overall efficiency of the communication circuits.

For a given distance, geographical location and time of transmission, there is a maximum frequency above which it is in general not possible to sustain communication, however much power is available at the sending end. As the frequency is reduced below

\* *Journal of the I.E.E.* 1926. Vol. 64, p. 710.

**Frequency Allocation—**

telegraphy and telephony, and it is perhaps not entirely a technical matter to decide the order of priority of these types of radio communication. Thus, in considering communication between this country and one of the Dominions, a certain range of frequencies will be available in practice; some of which are more favourable than others. It is a conceivable decision that the national interests would be best served by giving broadcasting pride of place, and so allocating to this particular service the highest, and therefore most efficient, frequency channel available. There may, however, be other views which demand that high-speed telegraphic communication is the most important service to safeguard. Alternatively, there may be a case, in the future, for giving special consideration to the needs of facsimile transmission as one of the most effective means of communicating special printed material and pictures. These are all matters involving questions of policy as well as technique; and it is to be noted that they are under active discussion at the present time in America by the Federal Communications Commission, the body responsible for frequency allocation in U.S.A.

**Conclusions.**—In conclusion, it may be said that the foregoing remarks amount briefly to a pro-

posal that careful and adequate use should be made of our present scientific knowledge of radio wave propagation as part of the foundation upon which to base a revised scheme of frequency allocation for long-distance radio communication of all types. This knowledge should naturally be used in a complementary manner to the results of the experience of all those who are, and have been, responsible for the practical design and operation of such communication circuits, and who will undoubtedly have already formed certain opinions as to the efficacy and limitations of the present distribution of radio frequencies on the basis agreed to over six years ago. That much practical material of the requisite type is already available was illustrated

by the article published in *Wireless World* for August, 1944, by J. A. Smale, in which a few excellent examples were given of some of the existing possibilities of world-wide communication, and of the steps that are taken to counteract the vagaries of the ionosphere.

**RADIO AND REHOUSING**

**I**N the report of the Committee convened by the I.E.E. to study electrical installations in relation to post-war building, wiring for telecommunication services of all kinds is dealt with. It is proposed that each house should be provided with a duct through the foundations for telephone, wire broadcasting or "wired television" if the latter is introduced at some future date. It is also recommended that a fixture



**MAN POWER.** The American Signal Corps transmitter-receiver, the SCR 694, which is used in forward areas, being transported as a three-man pack. On the move it draws its power from batteries, but under static conditions from a hand generator as shown in the lower photograph

for an outdoor aerial be provided, normally at the back of the dwelling and that an internally glazed porcelain lead-in tube should be cemented into the wall with a slope downwards towards the outside.

The provision of continuous wall ducts in the skirting or a deeply grooved picture rail is suggested to house internal telecommunication wiring, including extension loud-speaker leads.

Telecommunication problems in larger buildings such as blocks of flats and hospitals are also dealt with. The report is published by H.M. Stationery Office and the title is *Post-War Building Studies No. 11, Electrical Installations.*

# ARMY SET—Type 76

## Crystal Control of Operation between 2 and 12 Mc/s on Pre-selected Spot Frequencies

**T**HIS transmitter is intended primarily for use by Commando formations working in advance of the main forces, sometimes in semi-isolation and nearly always under very difficult campaigning conditions. Stark simplicity and ruggedness are, therefore, the key-notes of its design, there being no place for unnecessary frills and elaborations.

From the circuit diagram it will be seen that two valves only are employed; one is a crystal oscillator whilst the main function of the other is that of a power-amplifier. Both valves are tetrodes with characteristics somewhat similar to the well-known American 807.

The crystal oscillator, V<sub>1</sub>, is a modified form of the Pierce circuit, which, having the advantage that no tuning controls are required, admirably suits the purpose of this set. Change in frequency is effected simply by changing the crystal, six of which are included,

the desired one being selected by the switch S<sub>1</sub>.

Grid bias for V<sub>1</sub> is provided partly by the cathode resistor R<sub>2</sub>, and partly by the grid leak R<sub>1</sub>. As the voltage produced by the latter is dependent upon the amplitude of the oscillations, which are in turn governed by the activity of the particular crystal in use a reasonably constant output is obtained at all frequencies.

### PA Circuit

As the transmitter is intended for operation on predetermined spot frequencies within a band of 2 to 12 Mc/s it seems almost certain that the second stage, V<sub>2</sub>, will sometimes be operating as a straightforward power amplifier and sometimes as a combined

frequency doubler and output stage. This is based on the assumption that it is most unlikely crystals having a fundamental oscillation frequency higher than about 6 Mc/s would be used in a set of this kind.

There being no tuned circuits in either the oscillator stage or the input to V<sub>2</sub>, the mode of operation must be governed solely by the frequency to which the anode circuit of V<sub>2</sub> is tuned. This comprises the variable condenser C<sub>9</sub> and either the inductance L<sub>1</sub> or L<sub>3</sub>. It is thus possible to obtain at least two transmission frequencies from any one crystal having a fundamental frequency between 2 and 6 Mc/s, merely by tuning the PA circuit either to the fundamental frequency of the crystal or to its second harmonic. As the RF output from the Pierce oscillator is generally rather small it is very doubtful if third-harmonic operation would be worth-while. Some twelve transmission frequencies will therefore

The various switches and tuning controls on the Army set Type 76 can be located by the lettering, which is the same as that used in the theoretical circuit diagram.

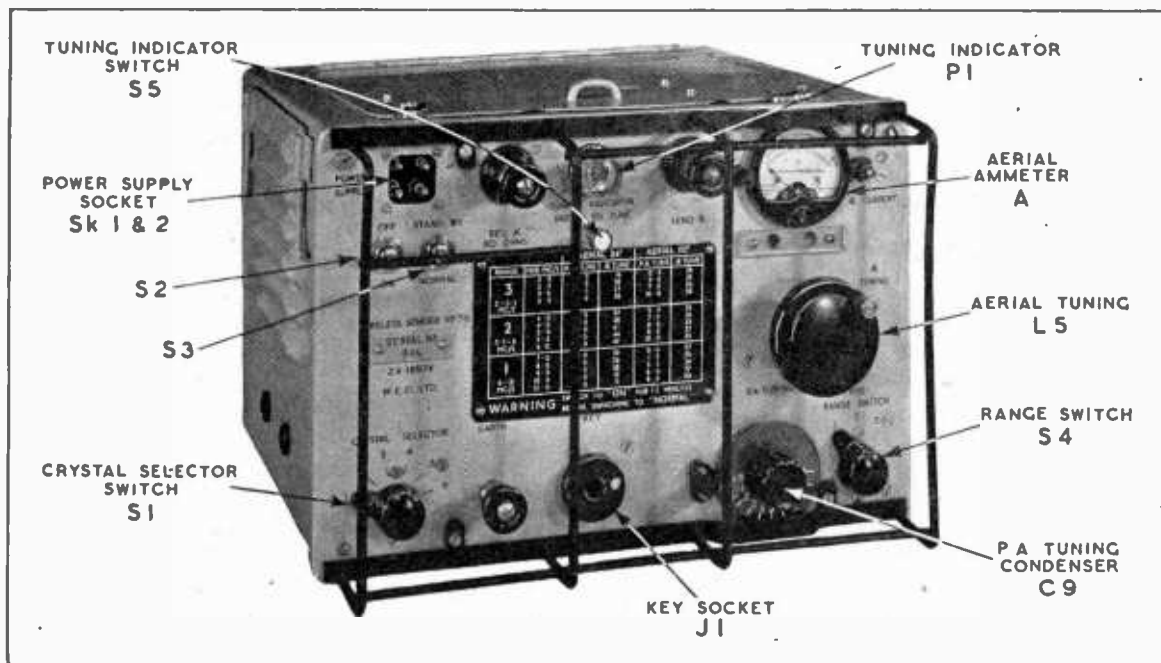

**Army Set—Type 76**

be available with the six crystals for which provision is made.

Biasing arrangements for the PA stage are similar to those of V1: R8 provides the minimum grid bias and R5 the additional

range switch S4 make the aforementioned inductance changes, at the same time short-circuiting and earthing the idle part of L1 or L3 as required. Section (c) performs the somewhat unusual function of joining the lead from

until the transmission is terminated. Obviously, the receiver has to be disconnected from the aerial during actual transmission periods and this is effected by the keying relay. With the key "down" contacts 3 and 4 are

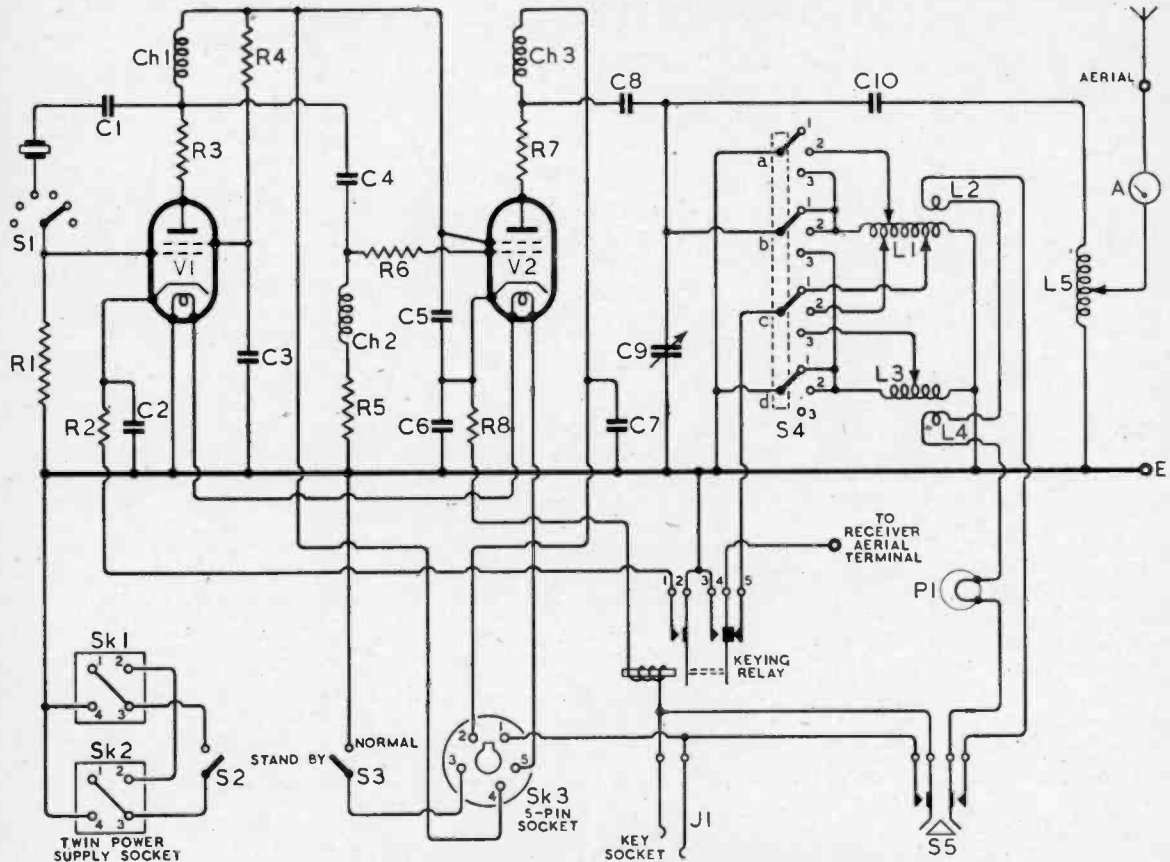

Complete theoretical circuit diagram of the CW transmitter—Army Set Type 76. For the sake of clearness, only one of the six crystals connected to switch S1 is included. Relay contacts are shown in the key "up" position.

bias needed for Class "C" amplification or for harmonic generation, as the case may be. Resistors R3, R6 and R7 are anti-parasitic resistances.

As already stated the tuned anode circuit for V2 consists of the variable condenser C9 and the inductance L1 or L3. Actually either a portion only or the whole of L1 is used, depending on the setting of the range switch S4. This is a four-pole three-way switch and its three positions enables C9 to cover the following frequency bands:—

2—3.5, 3.5—6, 6—12 Mc/s.

The PA circuit is shunt-fed through the choke Ch3 and condenser C8.

Sections (a), (b) and (d) of the

aerial terminal on the receiver, which comes in through the relay contacts 3, 4 and 5, to tapings on L1 or L3.

**"Break-in" Operation**

This serves a two-fold purpose. In the first case, it ensures that the input circuit of the receiver is always correctly matched to an aerial tuned to the particular band of frequencies in use and, secondly, it enables the receiver to be operated continuously, so permitting reception of any incoming signals during the keying intervals. This system is known as "break-in" operation, as the distant station can immediately ask for a repeat of any part of the message without having to wait

made and the receiver aerial is earthed. In the key "up" position relay contact 4 makes with contact 5 and the receiver is then connected to the aerial via the PA anode circuit, the condenser C10 and matching coil L5.

Coils L2 and L4, in conjunction with the lamp P1 and a spring-loaded press switch S5, together form a visual tuning indicator for use when adjusting the PA circuit. Switch S5 not only completes the indicator circuit when required but it also short-circuits the key contacts, thus starting up the transmitter. Correct tuning of the PA circuit is indicated by maximum brilliance of the lamp P1. Having tuned this circuit the aerial circuit is



then adjusted for maximum current in the aerial as indicated by the aerial ammeter A.

### Simplicity of Operation

From the foregoing it will be seen that there are two main tuning controls only, namely C<sub>9</sub> and L<sub>5</sub>. Subsidiary adjustments, such as changing crystals and selecting the required frequency band, are made by switches S<sub>1</sub> and S<sub>4</sub>.

There are two other switches shown on the circuit diagram the functions of which may appear a little obscure. Switch S<sub>3</sub>, a single-pole make-and-break type and marked "stand-by" in the open position and "normal" in the closed position, is used to start up the rotary transformer in the power supply unit as a preliminary to actual transmission. While receiving, this switch would be put to "stand-by," thereby conserving the LT current; the HT generator consumes only about 2½ amps at 12 volts when running light.

The switch S<sub>2</sub> is the main on-off switch and merely makes or breaks the LT supply from the battery.

With S<sub>3</sub> at "stand-by" and S<sub>2</sub> "on" LT current is supplied to the valve filaments only, the two valves together consuming 0.9 ampere at 12 volts. The total consumption of the set when transmitting is about 8 amps, but this load is applied only during the actual periods when the key is down.

Interconnection between transmitter and power unit is made

but there is a very good reason for it. Whilst being normally a battery-operated transmitter this type of power supply is not the most convenient for fixed

Circuit diagrams of the alternative power units are reproduced here in order that the various leads connected to the 4- and 5-pin sockets on the transmitter

Theoretical circuit of the battery-operated power unit type No. 18.

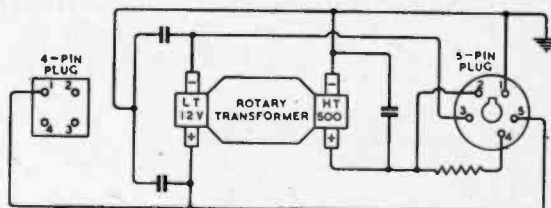

station operation, so that if an AC supply is available advantage can be taken of it for operating the set. All that is necessary is to replace the rotary transformer power supply unit by one incorporating a suitable transformer and rectifier.

Switches S<sub>1</sub> and S<sub>2</sub> still serve the same function as formerly, but they do so in a different manner. The same applies to the power supply socket. This incidentally consists of two similar sockets assembled in tandem, one facing outwards from the front panel and the other facing inwards. Interconnection is made as shown with S<sub>2</sub> incorporated in the lead connecting the No. 3 sockets on each unit. Now when battery operation is desired the LT accumulator is connected to sockets 1 and 4, the latter being the negative. With an AC supply power is fed into sockets 2 and 3, so whichever form of supply is used S<sub>2</sub> always breaks the circuit when "open." The AC supply unit would have a twin cable for power instead of

can be traced through to their several destinations. The power unit, whether battery or mains operated, is housed with the transmitter in a stout metal case measuring 12½ in. x 12 in. x 8½ in. and weighs 30 lb. with the former, and 33 lb. with the latter, supply unit in situ. The RF power output is given as 20 watts.

As the full load consumption of the transmitter is about 90 watts at 12 volts fairly frequent recharging of the battery is necessary and in the field this is catered for by a very compact self-contained petrol-electric charging set, the hollow bedplate of which forms a fuel tank.

The receiver generally used with this transmitter is the type R109A, an eight-valve superhet with waveband switching, a built-in loudspeaker, provision for using telephones, and powered by a vibrator supply unit. AVC is not included, as the set is intended for CW reception only. Coverage is 2 to 12 Mc/s in two ranges.

### OUR COVER

THE illustration on this month's cover is of the Army's Type 76 transmitter, described above, and its companion receiver R109A, photographed under battle conditions on the Western Front. It is interesting to recall that the 76 set was the Arnhem men's last link with this country.

### "CLASSIFICATION OF COPPER AND COPPER ALLOYS"

THIS recent publication, issued by the Copper Development Association, 9, Bilton Road, Rugby, contains in tabular form a vast amount of information on the chemical and physical properties of the commoner copper-base materials in commercial use, including electrical conductors.

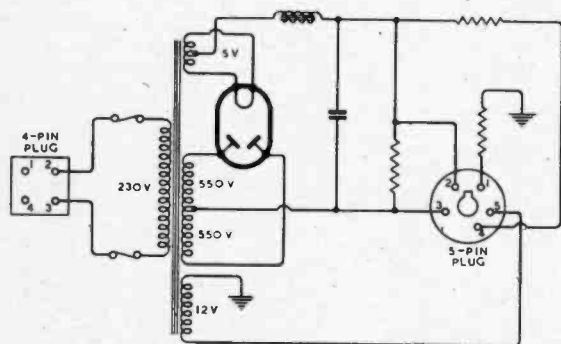

Circuit diagram of the rectifier supply unit No. 14 for use where AC mains are available.

by means of two cables, one a five-way and the other a single conductor. This may appear unnecessarily complicated in an otherwise strictly austere set,

the single conductor which suffices for the battery unit. Thus no damage will be done if the supply is changed without first fitting the appropriate power unit.

# VALVE VECTORS

## Relationship Between Input and Output AC Voltages and Currents and the DC Supply

MANY students have no clear mental picture of the vector relationship between the input and output voltages and currents of a valve. Attempts, made by various writers\* to remedy this have not, in the author's opinion, proved entirely successful because they appear either to violate Ohm's law or to ignore the DC conditions in the output circuit. It is possible to represent the actual as well as the equivalent generated AC voltages and currents on the vector diagram, and this short

By K. R. STURLEY,  
Ph.D., B.Sc., A.M.I.E.E.

valve amplifier having a resistance anode load and a grid input AC voltage  $E_g$ , as shown in Fig. 1. Assuming the valve to be represented by a constant voltage AC generator of  $\mu E_g$  volts and internal resistance  $R_a$ , where  $\mu$  is the amplification factor of the valve

AC anode current produced by the generated voltage  $\mu E_g$  and must not be confused with the actual AC change,  $I_a$ , superimposed upon the DC current  $I_0$  taken from the HT source,  $E_b$ , by the valve. Neither Fig. 2(a) nor Fig. 2(b) take into account the fact that the valve is actually controlling power derived from the DC voltage source, and Fig. 3 is drawn to include this feature. Arrows indicate the directions in which the voltages and currents are acting. Points A and K correspond to the anode and cathode respectively and should be considered in relation

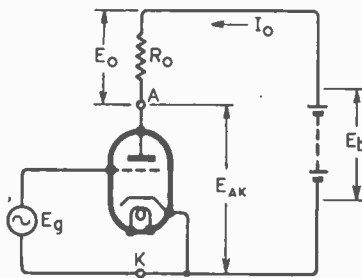

Fig. 1. Valve amplifier with resistive anode load.

article is offered as a solution to the impasse in which many students, and some teachers, find themselves when dealing with the problem.

The most important fact to grasp is that the grid input AC voltage and the voltage generated by the generator imagined to exist inside the valve are  $180^\circ$  out of phase; this is true whether the anode load is resistive or reactive. Many writers create difficulties for themselves and their readers by stating that the grid input AC voltage and the anode current are in phase with each other, whereas in actual fact the phase of the two vectors is determined by the anode output load conditions.

Let us consider the simplest

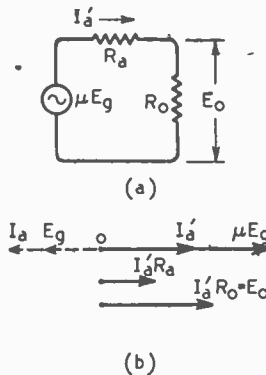

Fig. 2. (a) Equivalent circuit of Fig. 1 with the valve as a constant voltage AC generator. (b) Vector relationships of voltage and current for the equivalent circuit (a).

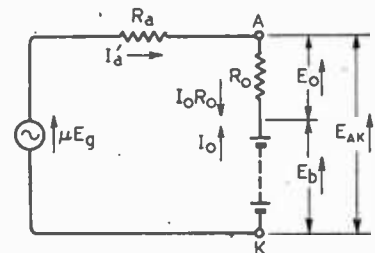

Fig. 3. Equivalent circuit for the valve amplifier of Fig. 1 including the DC voltages and currents.

and  $R_a$  its slope resistance, the equivalent AC circuit is that of Fig. 2(a). The voltage and current vectors are as shown in Fig. 2(b). The current  $I_a'$  is the

to Fig. 1. The generated AC output voltage and current vectors are unaffected by the inclusion of the DC voltage  $E_b$  and the DC anode current  $I_0$ . The actual voltage at the anode of the valve

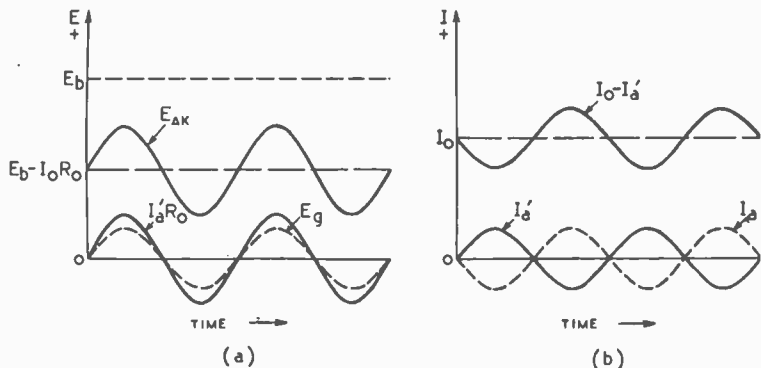

Fig. 4. (a) Voltage/time relationships; (b) current/time relationships for the valve amplifier.

\* "The Phase Convention of Currents and Voltages in Valve Circuits," Editorial, *Wireless Engineer*, March 1940, p. 95. Correspondence D. A. Bell, *ibid*, April 1940, p. 165.

consists of the sum of the DC and AC voltage components, since the voltage  $E_o$  developed across  $R_o$  by the generated current  $I'_a$  during its positive cycle is in the same

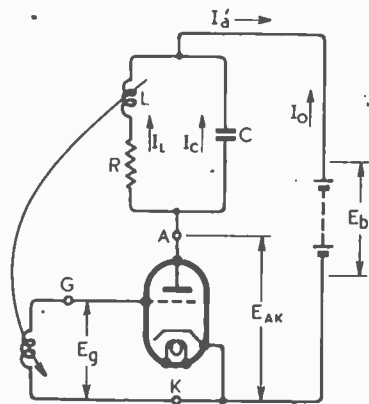

Fig. 5. Tuned anode oscillator.

direction as the DC voltage  $E_b$ . The DC anode voltage is  $E_b - I_o R_o$  so that the actual anode voltage is

$$E_{AK} = (E_b - I_o R_o) + E_o = (E_b - I_o R_o) + I'_a R_o$$

The voltage time relationships are therefore as shown in Fig. 4(a)

The total current in the valve is the difference between the DC and AC currents, i.e.,  $I_o - I'_a$ , because  $I'_a$  during its positive half cycle is in the reverse direction to  $I_o$ . The time relationship of the currents is as shown in Fig. 4(b). The actual AC current variation  $I'_a$  superimposed upon the DC current  $I_o$  is therefore seen to be  $180^\circ$  out of phase with the generated AC current due to the voltage  $\mu E_g$ , and is represented by the vector  $I'_a$  in phase with  $E_g$  as shown in Fig. 2(b). In this instance  $E_g$  and  $I'_a$  are in phase, but this is simply because the anode load is a resistance; when it is reactive  $I'_a$  will lag (inductive anode load) or lead (capacitive) upon  $E_g$ .

Two important points arise from this analysis regarding the valve as a generator of  $\mu E_g$  volts, (1) the generated voltage is  $180^\circ$  out of phase with the input voltage  $E_g$  and (2) the AC current produced in the anode load by the generated voltage  $\mu E_g$  is  $180^\circ$  out of phase with the actual AC current variation superimposed upon the DC anode current. The second point is entirely due to the fact that the valve is deriving

its power from  $E_b$ . Once these points have been appreciated there need be no confusion as to the vector representation of a valve circuit.

As a second illustration let us analyse vectorially the tuned anode oscillator of Fig. 5. We shall assume ideal conditions, viz., zero grid current and Class "A" operation. Grid current complicates the vector diagram by introducing an extra vector, and the more usual Class "C" operation has no material effect on the vector positions of the fundamental frequency components. Fig. 6 gives the equivalent circuit and Fig. 7 shows the vector representation. The oscillator frequency is greater than the natural frequency of the tuned circuit so that the AC current  $I'_a$  produced by the generated voltage  $\mu E_g$  is capacitive and leads upon  $E_o$ .

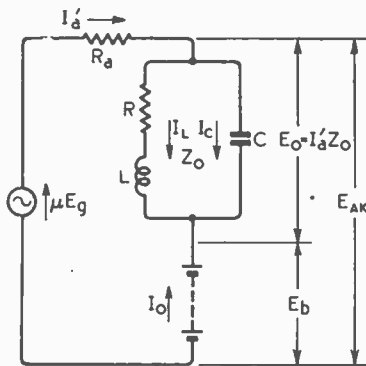

Fig. 6. Equivalent circuit of the tuned anode oscillator.

and to a less extent upon  $\mu E_g$ , i.e.,  $E_o$  lags behind  $\mu E_g$ . This is an essential condition if the coil L contains resistance because  $I_L$  must lag  $90^\circ$  behind  $\mu E_g$  in order that  $E_g$ , which equals  $-j\omega M I_L$ , may be  $180^\circ$  out of phase with  $\mu E_g$ . The vector representation of the actual AC current component superimposed on the DC anode current  $I_o$  is a vector of the same length as  $I'_a$  but  $180^\circ$  out of phase with it as shown by  $I'_a$ . It leads upon  $E_g$  by the same angle as  $I'_a$  leads upon  $\mu E_g$ . The time relationships of the voltage and current waves are illustrated in Fig. 8 and we see that the voltage wave at the anode of the valve is  $E_{AK} = E_b + E_o = E_b + I'_a Z_o$  if the DC resistance of the coil L is negligible. The generated AC current wave ( $I'_a$ )

leads slightly upon the anode voltage thus making the actual AC current variation superimposed upon the DC feed current  $I_o$  lead by the same angle upon the  $180^\circ$  out-of-phase position with respect to the generated voltage  $\mu E_g$ .

The grid coil is wound in a direction such that the mutual

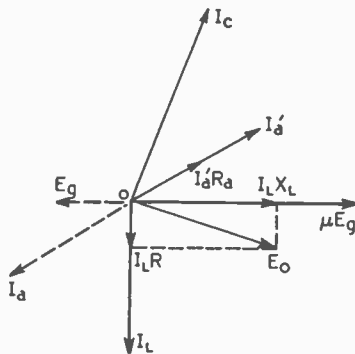

Fig. 7. Vector diagram for the tuned anode oscillator.

inductance between the anode and grid coils increases the inductance, measured across the points A to G, above a value equal to the sum of the separate inductances of the two coils. The voltage generated in the grid coil by an AC current,  $I_L$ , in the anode coil L therefore lags  $90^\circ$  behind the current  $I_L$  producing it, and equals  $-j\omega M I_L$  where M is the value of the mutual inductance between the coils. If either the anode or grid coil is reversed the generated grid voltage becomes

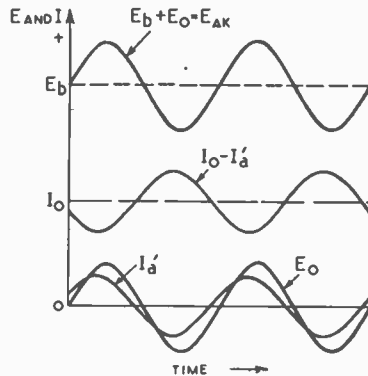

Fig. 8. Voltage and current/time relationships for the tuned anode oscillator.

$+j\omega M I_L$  and leads upon  $I_L$  by  $90^\circ$  thus preventing any possibility of oscillation.

# U.S. FREQUENCY PROPOSALS

## American and International Allocations Above 25 Mc/s

CONSIDERABLE interest has been centred around the post-war re-allocation of frequencies, which has often been stressed in these pages as an urgent necessity. It is felt, therefore, that readers will be interested to have the tabulated proposals for international and American allocations put forward by the U.S. Federal Communications Commission after lengthy discussions with Government and industry officials. It should be pointed out that the allocations for American services have yet to be agreed upon by the U.S. Government, whilst those for international use are simply proposals. So far as Great Britain is concerned, it is learned on enquiry at the General Post Office that the question of the post-war allocation of radio frequencies has been under the consideration of His Majesty's Government for some time in preparation for the resumption of international discussions. The Government is well aware of the proposals published in the United States and careful study is being given to them.

The proposals which cover that portion of the spectrum from 25 to 30,000 Mc/s, have brought forth strong comments in American circles, especially among advocates of frequency modulation. Proposals for frequencies below 25 Mc/s will be made later.

The plan introduces allocations for a number of new services, the most novel being that styled the Citizens' Radio Communications Service, which would occupy the 460-470 Mc/s band. A simplified licensing procedure is proposed by the F.C.C. for this service, in which no technical knowledge will be required, nor will the licensee be subject to an examination.

Because it has been concluded that the carrier-current system is not a practical solution for all the needs of the railways, by reason of its dependence on wires running beside the track, the 156-162 Mc/s band will be allocated to railway radio. In addition, six bands above 1,900 Mc/s are proposed for experimental use.

Provisions are also made for a new service for "highway safety."

So far as amateur allocations are concerned there seems to be general agreement. The Board of Directors of the American Radio Relay League has agreed to accept the proposals, feeling that they have received an allocation "that will well take care of our needs."

Ten bands have been allocated to amateurs. The only previously assigned band retained in this portion of the spectrum is that from 28-30 Mc/s. Instead of the four bands from 56-60, 112-116, 224-230 and 400-401 Mc/s previously allocated, provision is made for amateurs to use the following:— 50-54, 144-148, 220-225, and 420-450 Mc/s. In addition they have been granted five new channels above 1000 Mc/s: These are:— 1125-1225, 2500-2700, 5200-5750, 10,000-10,500, and 21,000-22,000 Mc/s.

Although the Commission considers international broadcasting "a service of great significance," it has cancelled the only frequency above 25 Mc/s previously allocated for this service. It is, how-

ever, stated that it will endeavour to allocate adequate frequencies below 25 Mc/s when the lower frequencies are dealt with.

There has been some shuffling of television and FM allocations which seems to have caused considerable heartburn in the industry, especially among advocates of FM. It is understood that the re-allocation of FM frequencies has been largely influenced by propagation data supplied in secret session by the U.S. War Department. The allocation of 84-102 Mc/s in place of 40-50 Mc/s proposed by the industry is adversely criticised because of the 500,000 FM receivers said to have been purchased by the public. The F.C.C. report, however, stresses that "The cost to the public as the result of moving FM from its present band will not be great. . . . The present receivers are, of course, several years old. Even if the present FM band were retained these receivers would become partially obsolete since an expansion of the existing 42-52 Mc/s band would place a number of stations out of range."

It is contended by the advocates of this frequency change that F2 layer transmissions on 44 Mc/s created interference from a station working in the same channel over 2,000 miles away for more than 700 hours during one sunspot cycle. The F.C.C. states that "this interference would be concentrated principally during two or three years of the sunspot maximum and necessarily would be greater from stations farther apart. . . . These computations were based on ionospheric measurements at Washington, D.C."

Television services have been granted the same number of channels as previously occupied below 225 Mc/s although in different bands. The proposals allow for six channels in each of the 44-84 and 180-216 Mc/s bands. In addition, the 480-920 Mc/s band has been proposed for the development of high-definition and colour television, and the 1225-1325 Mc/s band for television relay purposes.

"CLIX" SHROUDED CR TUBE  
SOCKET



This component is designed to give protection for all live leads, without adding to the complication of wiring. The socket plate can be removed from the shroud for wiring and the spigot keyway can be mounted in various positions relative to the double cable grip, which permits segregation of high and low potential leads. Socket plates with 9, 10 or 12 connections are available.

F.C.C. PROPOSALS FOR FREQUENCY ALLOCATIONS

Freq. Band Mc/s	Proposed International Allocation	Proposed United States Allocation	Freq. Band Mc/s	Proposed International Allocation	Proposed United States Allocation
25.015-27.305	Fixed and mobile, except aeronautical and maritime (max. power 500 w.)	Gov. and non-Gov., fixed and mobile (1)	524-920	Broadcasting	Television
27.305-27.335	Scientific, industrial and medical	Scientific, industrial and medical	920-940	Broadcasting	Exp. broadcast services
27.335-28	Fixed and mobile, except aeronautical and maritime (max. 500w).	Gov. and non-Gov., fixed and mobile (1)	940-960	Fixed and broadcasting	Fixed and exp. b'casting
28-30	Amateur	Amateur	960-1125	Navigation aids	Navigation aids
30-30.5	Fixed and mobile, except aeronautical	Government (2)	1125-1225	Amateur	Amateur
30.5-32	" " "	Non-Gov., fixed & mobile	1225-1325	Fixed and mobile, except aeronautical	Television relay
32-33	" " "	Government	1325-1450	Fixed and mobile	Government
33-34	" " "	Non-Gov., fixed & mobile	1450-1500	Air navigation aids	Air navigation aids
34-35	" " "	Government	1500-1550	Meteorological	Meteorological
35-36	" " "	Non-Gov., fixed & mobile	1550-1650	Aeronautical mobile	Aeronautical mobile
36-37	" " "	Government	1650-1900	Fixed and mobile	Government
37-38	" " "	Non-Gov., fixed & mobile	1900-2300	Fixed and mobile, except aeronautical	Non-Gov., fixed and mobile
38-39	" " "	Government	2300-2500	Air navigation	Air navigation
39-40	" " "	Non-Gov., fixed & mobile	2500-2700	Amateur	Amateur
40-40.96	" " "	Government	2700-2800	Meteorological	Meteorological
40.96-41	Scientific, industrial and medical	Scientific, industrial and medical	2800-3900	Navigation aids	Navigation aids
41-42	Fixed and mobile, except aeronautical	Government	3900-4550	Fixed and mobile, except aeronautical	Non-Gov., fixed and mobile
42-44	" " "	Non-Gov., fixed and mobile (3)	4550-5200	Fixed and mobile	Government
44-50	Broadcasting, fixed and mobile	Television	5200-5750	Amateur	Amateur
50-54	Amateur	Amateur	5750-7050	Fixed and mobile, except aeronautical	Non-Gov., fixed and mobile
54-60	Broadcasting, fixed and mobile	Television, fixed and mobile	7050-10000	Fixed and mobile	Government
60-66	" " "	" " "	10000-10500	Amateur	Amateur
66-72	" " "	" " "	10500-13000	Fixed and mobile, except aeronautical	Non-Gov., fixed and mobile
72-78	" " "	" " "	13000-16000	Fixed and mobile	Government
78-84	" " "	Television	16000-18000	Fixed and mobile, except aeronautical	Non-Gov., fixed and mobile
84-88	Broadcasting	Educational FM	18000-21000	Amateur	Amateur
88-102	"	Commercial FM	21000-22000	Fixed and mobile	Government
102-108	Fixed, mobile and broadcasting	(Later allocation to FM, Non-Gov., emergency services, facsimile or television)	22000-26000	Fixed and mobile, except aeronautical	Non-Gov., fixed and mobile
108-112	Air Navigation (Localisers)	Government	26000-30000	Experimental	Experimental
112-118	Air Navigation (Ranges)	"	Above 30000		
118-122	Aeronautical mobile (Airport Control)	Airport Control			
122-132	Aeronautical mobile	Aeronautical mobile			
132-144	Fixed and aeronautical mobile	Government			
144-148	Amateur	Amateur			
148-152	Fixed and aeronautical mobile	Government			
152-156	Fixed and mobile, except aeronautical	Police			
156-162	" " "	Non-Gov., fixed and mobile (4)			
162-170	Fixed and mobile	Government			
170-180	Navigation aids	Navigation aids			
180-186	Broadcasting, fixed and mobile	Television and Government			
186-192	" " "	" " "			
192-198	" " "	Televis'n, fixed & mobile			
198-204	" " "	" " "			
204-210	" " "	" " "			
210-216	" " "	" " "			
216-220	Fixed and mobile	Government			
220-225	Amateur	Amateur			
225-400	Fixed and mobile	Government, 75 aeronautical channels for non-Gov.			
400-420	" " "	Government			
420-450	Air navigation and amateur	Amateur and air navigation (5)			
450-460	Air navigation	Non-Gov., fixed and mobile (6)			
460-470	Fixed and mobile	" " "			
470-480	Broadcasting	Facsimile			
480-508	Broadcasting	Television			
508-524	Air navigation aids	Television (7)			

(1) Distribution of channels in the 25-28 Mc/s band. Exact channels to be determined later.

22 channels. Motion picture, relay press, relay broadcast and geophysical.

5 " Power and petroleum.

10 " General experimental.

(2) On the basis of an assumed average channel width of 40 kc/s minimum provisions will be made for the following services in the 30-42 Mc/s band:—

35 channels. Police.

15 " Fire.

10 " Urban, transit, forestry and conservation.

10 " Power and petroleum.

4 " Special emergency.

33 " Forestry and conservation.

9 " Maritime mobile, geophysical.

12 " General highway, mobile (exp. and marine).

8 " General experimental.

(3) Provisions will be made for the following services in the 42-44 Mc/s band (40 kc/s channels):—

21 channels. Police.

12 " General highway, mobile (exp.) and marine.

11 " General experimental.

Provisions will be made for the temporary operation of existing commercial, educational and experimental FM stations now operating between 42 and 50 Mc/s.

(4) Provisions will be made for the following services in the 156-162 Mc/s band (60 kc/s channels):—

20 channels. Fire.

7 " Forestry, marine, urban and mobile (exp).

6 " Special emergency.

5 " Power and petroleum.

4 " Motion picture, relay press, relay broadcast and geophysical.

33 " Railways (end-to-end, train-to-train, station-to-train).

5 " General experimental.

(5) To be used temporarily for "special" air navigation aids. Band to be exclusively "amateur" when no longer required for "special" air navigation aids; meanwhile, amateur power to be limited to 50 watts.

(6) To be used temporarily for "special" air navigation aids.

(7) To be used temporarily for air navigation aids.



# UNBIASED

## Post-war Planning

A MAN who ought to know better was complaining to me the other day about the way in which the war, immediately it broke out, rendered completely useless the station names on the dial of his broadcast set. In actual fact, I think that a large part of his disgruntlement was due to the fact that his receiver had a particularly elaborate dial, complete with coloured lights and all the other red-herrings which some manufacturers used to employ in order to distract attention from the more vital parts of the set (after the manner of some females who are a bit too heavy-handed with the lip-stick and rouge). In order to save a lot of unnecessary correspondence I had better say at once that I don't mean that every manufacturer and every female who does this sort of thing has nothing else in the cupboard to offer. On the contrary, some of the soundest designs I know are, in my opinion, a bit too overloaded with non-essential trimmings.



"Non-essential Trimmings."

Station names on dials are, I think, a relic of the adolescent days of the radio industry when it tried to please two classes of set user and succeeded in satisfying neither. Technical men like myself, to whom programmes are merely a form of carrier-wave modulation useful for testing purposes, were not much interested in them and would have preferred kilocycles per second or even geometrical or purely arbitrary "degrees," plus a calibration chart. The ordinary listener didn't care whether the programme originated in Timbuktoo or Wigan, so long as it was the sort of thing he wanted to listen to.

As an example of what I mean, I make bold to say that in pre-war days fully 50 per cent. of the people who listened to Luxembourg were completely ignorant of the name or geographical position of the country in which the station was

By

## FREE GRID

situated. Only the other day, in fact, I heard a bright young thing in the train look up from her copy of the *Daily Scream* and remark to her companion that she supposed that this Luxembourg where the American troops had been fighting had been named after that "divine pre-war wireless programme."

Nowadays, of course, when B.B.C. transmitting stations have to be strictly "incog," as they have been for the past five years, people have no idea to what station they are tuned when receiving any of the B.B.C.'s programmes; nor indeed do they care any more than they care which particular generating station is providing the juice to light their house. It is the light they want, and it is all the same to them whether it comes from Battersea or Little Buggsly.

It is to be hoped, therefore, that manufacturers will not be so foolish as to try to give us station names in our post-war sets, and that the B.B.C. will not be so misguided as to encourage them by printing station names in the *Radio Times*. For the ordinary listener, dials need to be calibrated with the type of programme which will always be found on that setting, and I look forward to seeing sets with their dials labelled with such things as "Moral Uplift," "Sentimental Slush," and so on.

It will, however, be little use for manufacturers to give us this sort of dial until they have extracted a promise from the B.B.C. that any particular class of programme will always be found on the same wavelength. I don't, for instance, want to find Mrs. Mopp making an unexpected appearance on the Bach Cantata wavelength or *vice versa*.

## Origins of Radar

INTERESTED as I was in the remarks concerning the origins of radiolocation made by the Editor in his March commentary, I cannot agree with the suggestion or conclusion, implicit in his musings, that the earliest record of the use of "reflected" electro-magnetic waves for the purpose of locating distant objects was the ionospheric research initiated some twenty years ago.

It is painfully obvious that the Editor is floundering in a morass of ignorance almost as abysmal in its

depth as that in which certain members of the Brains Trust disported themselves recently when discussing the question of whether or not plants possessed intelligence. It was quite clear that none of them was acquainted with the researches of Sir Jagadar Bhowe and other Indian savants into this very question.

I take it that the Editor is equally ignorant of these matters, otherwise he would have been acquainted



True Radar.

with the fact that it has been experimentally verified that certain sensitive plants have been found to possess the power of locating approaching objects and even of distinguishing friend from foe. Thus, the succulent strawberry is easily able to distinguish the approach of the friendly cat from that of the predatory *homo sapiens*. The plants are able to do this by sending out certain "etheric emanations" which are "characteristically modulated" and reflected by the approaching object. If this is not radiolocation I should like to know what is. Since it is generally agreed that plant life preceded human or, indeed, any form of animal life on the earth, it looks as though RDF is a lot older than the Editor thinks.

Of course, to come to more modern times, anybody like myself who habitually struggles with a box of matches to locate an errant collar stud underneath a wardrobe is employing reflected electro-magnetic waves generated by the match. If I could have daylight for my daily search I should still be employing reflected electro-magnetic waves, but it could not then be labelled true RDF as I should not be responsible for generating the waves, as in the case when I use a match. I purposely avoid using daylight as I like to be up-to-date.

Incidentally, the earliest known instance of ordinary DF in which the object to be located is actually radiating is, I believe, the seed germinating in the ground and struggling upwards towards the sun.

# Angles on **BRIMAR PRESTIGE**

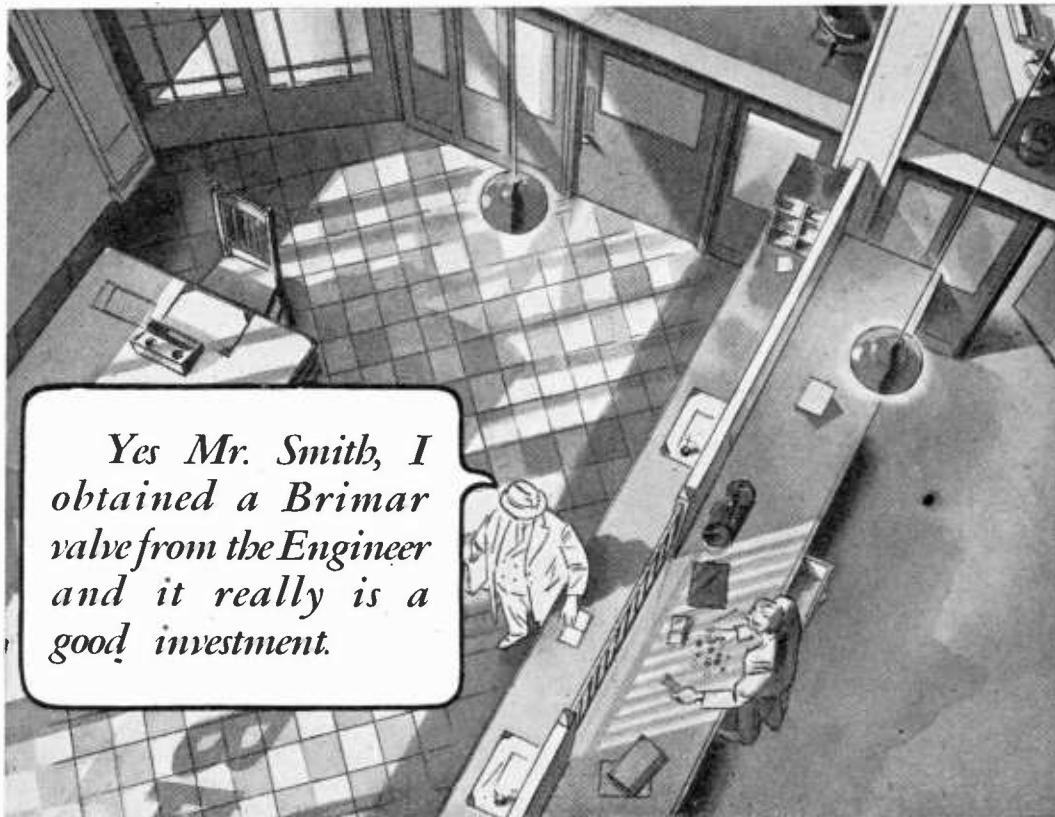

*The use of the correct Brimar Valves in a radio set is as good as a guarantee of peak performance. Valves are still in short supply, but you may be fortunate to get the Brimar Valve you need.*

# BRIMAR

(BVA)

# VALVES

STANDARD TELEPHONES AND CABLES LIMITED, FOOTSCRAY, SIDCUP, KENT.



Clear as a  
*Crystal*

**AND HERE IS THE REASON . .**

. . . the answer has been found in Bullers Low Loss Ceramics to the problem of Dielectric Loss in High Frequency circuits.

Years of Laboratory research and development have brought these materials to a high degree of efficiency. To-day they are in constant use for transmission and reception, and play a vital part in maintaining communications under all conditions.



**Made in Three Principal Materials**

**FREQUELEX**  
An Insulating material of Low Dielectric Loss, for Coil Formers, Aerial Insulators, Valve Holders, etc.



**PERMALEX**  
A High Permittivity Material. For the construction of Condensers of the smallest possible dimensions.

**TEMPLEX**  
A Condenser material of medium permittivity. For the construction of Condensers having a constant capacity at all temperatures.

**BULLERS, LTD.**  
THE HALL,  
OATLANDS DRIVE,  
WEYBRIDGE, SURREY  
Telephone :  
Walton-on-Thames 2451  
Manchester Office :  
196, Deansgate, Manchester.

**Bullers**

LOW LOSS CERAMICS

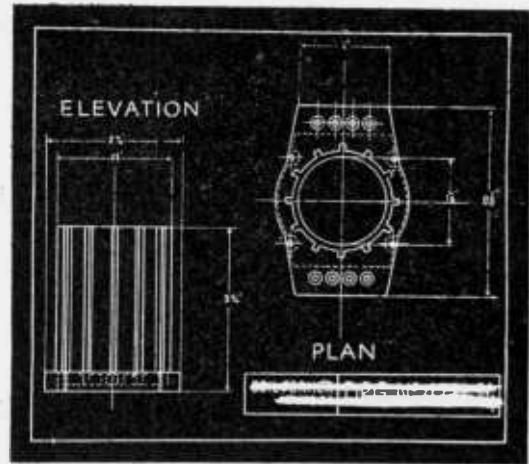

**BETTER INSULATION WITH RADIO-FREQUENCY MOULDED COMPONENT PARTS**

**T**HE considerably improved cure obtained by using radio-frequency heating in the production of plastic component bases or resin impregnated laminated boards, results in the finished product having a very much lower water content. It also has almost half the water absorption characteristic of mouldings produced by any other method.

To these advantages can be added a generally increased electric strength and wet and dry surface resistivity. In low loss grade materials the loss factor is also decreased. All these factors together combine to produce a better insulator than can otherwise be achieved.

Rediffusion engineers have also carried out considerable research in the treatment of metals by radio-frequency eddy-current heating, and have been successful in solving many heating problems involving localized heat at high temperature.

Rediffusion radio-frequency heating sets are specially constructed to suit the requirements of individual industrial production methods. They are fully enclosed and fitted with all the necessary safety devices. Rediffusion research engineers would welcome the opportunity of discussing the use of radio-frequency heating with manufacturers.

**REDIFFUSION Ltd.**

*Designers and Manufacturers of Radio Communication and Industrial Electronic Equipment*

SUBSIDIARY OF BROADCAST RELAY SERVICE LIMITED

VICTORIA STATION HOUSE, LONDON, S.W.1. Phone: Victoria 8831



# RADIO SPECTROSCOPY

## What It Is, and How It Works

By THOMAS RODDAM

THE radio spectroscope seems to have made its first public appearance in 1938, but very little has been heard of it since then, and it is likely that many readers will not have seen any of the few articles describing the device. It is a remarkably interesting instrument, however, and appears to have a wide range of application; it is, moreover, an instrument which can easily be constructed by anyone who already has a communications receiver and a cathode-oscilloscope. With these two pieces of basic equipment available, a simple two-valve adaptor can be constructed which will form a basis for the study of the properties of the radio spectroscope, and I know of no field in which so much fresh ground can be explored for so little constructional effort.

Essentially, the function of the radio spectroscope is to display on the screen of a cathode-ray tube, "or other indicating means," as they say in Chancery

made, and some idea of the sort of modulation can be obtained. During the day, for example, some 5 or 6 marks show the usual B.B.C. channels; at night there is a thick forest of indications as the whole mob of European stations come in. To watch the tube through the twilight period separating day conditions from night affords a very striking picture of the change in propagation conditions which takes place; the dependence on frequency is very clearly shown. This is only one application. The amateur transmitter can monitor his own transmission and its sidebands; if he is transmitting W/T he can check that his key-clicks are not occupying an excessive bandwidth. The sideband structure of a frequency-modulated transmission can be studied, and any frequency modulation of a transmitter which is meant to be amplitude modulated can be observed. Other applications will

plest form it is, indeed, nothing more than an ordinary receiver with frills. Imagine any one-knob receiver, with a variable resistor ganged to the tuning knob. Across this resistor is applied a convenient DC voltage—say, 200 volts. One end and the tapping point are taken to the X-plates of a cathode-ray tube. Then, as the tuning knob is turned, the voltage tapped off varies, and the X-deflection of the spot on the tube is varied in sympathy. The position of the spot is directly related to the frequency to which the receiver is tuned, and a scale can be stuck on the tube relating frequency and spot position. The receiver output is now connected to the Y-plates actually; unless the receiver uses an infinite impedance detector, it is most convenient to use the detector output, for then we shall get some output even when an unmodulated carrier is received. With this set-up, as the receiver is tuned up and down the band, the spot on the cathode-ray tube

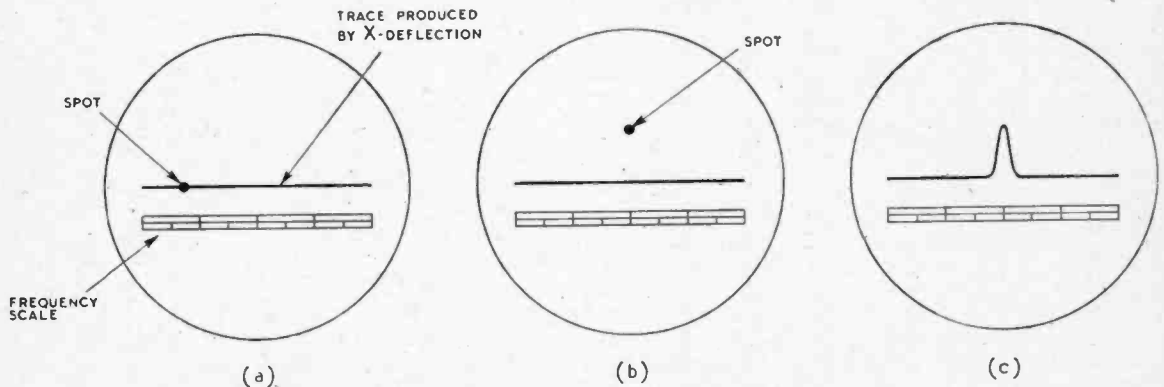

Fig. 1. Illustrating the principle of the radio spectroscope (see text).

Lane, an analysis of the radio-frequency energy reaching a receiving aerial. In simpler language, if the instrument is set up to cover, say, the medium frequency broadcasting band, you can see which stations are actually being picked up by your aerial. In addition, a rough estimate of field strength can be

spring to mind as soon as the instrument is in use.

Like a mule, the radio spectroscope has two parents of very different kinds; unlike the mule, however, it has more hope in the future. The conjunction of a normal receiver and a visual alignment generator begat the radio spectroscope. In its sim-

moves across in the X-direction, and whenever a station is in tune moves also in the Y-direction. In Fig. 1 (a) we see first the afterglow trace produced by the spot being swept across the tube in the X-direction only. In Fig. 1 (b) a station is in tune, and the spot has been deflected vertically by the rectified carrier; if the receiver

**Radio Spectroscopy—**

tuning is swept quickly to and fro, the picture of Fig. 1 (c) is obtained, persistence of vision and after-glow combining to give a trace with a bump in it at the point where the signal is being received. There is no point in turning the tuning knob by hand; the addition of a tuning motor which reverses its direction of travel at each end of the band is an obvious step. This gives the basic radio spectroscope. Let us recapitulate. An ordinary receiver is tuned up and down its

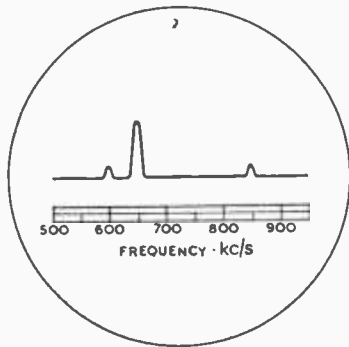

Fig. 2. Typical spectrogram of the medium-wave band showing one strong and two weak stations.

working band by a motor; the detector output from the receiver is applied to the Y-plates of a cathode-ray tube, and a voltage dependent on the position of the tuning knob is applied to the X-plates. The result is a picture on the tube like that of Fig. 2, which shows a strong station on 650 kc/s and two weak ones on 600 kc/s and 850 kc/s.

The arrangement described above is practically the Piltdown man of radio spectroscopes. A forward step is made by designing a tuning condenser system which can be continuously rotated in the same direction: this avoids the awkward speed variations and accelerating forces which the simple reversing system involves. Consequently, the rate at which the band is swept can be increased, and a motor running at 1,500 r.p.m. can be used. This gives 25 sweeps per second, and the picture is easy to watch. At this speed the potentiometer method of producing an X-shift is impossible: other means must be adopted. There are two simple solutions. If the motor is truly

synchronous, that is if it runs at 1,500 r.p.m. on 50 c/s mains, a time-base locked to the mains, or even, if linearity of frequency scale is not wanted, the mains voltage itself, can be used. If the motor is an ordinary induction type with some slip, running at 1,425 to 1,450 r.p.m. on 50. c/s mains this cannot be done. An ordinary time-base circuit is used, however, and this is locked to the motor speed. One simple way of providing a locking symbol is to mount a thin strip of Mumetal (or any other ferromagnetic material) on the end of the condenser shaft, and fix near this a moving armature pickup. The arrangement is such that once every revolution the gap is almost closed by the strip: this generates a short triggering impulse which always occurs at the same angular position of the condenser shaft. A diagram illustrating the method is shown in Fig. 3. This shows the end of the condenser shaft, an edge-on view of the Mumetal strip, and the pickup coil. Obviously, either pickup system or armature must be polarised. If Mumetal strip is used, there remains a choice between a permanent magnet system, and one passing direct current through the coil. The usual basis for such a choice is an examination of the junk-box to find either an old headphone or gramophone pickup to serve as a permanent magnet system, or some old transformer stampings which can be cut up for use in a DC excited system. Convenience is the only criterion of choice.

**Condenser Design**

In the description above I have skated lightly over the fact that the tuning condenser is being spun continuously at 1,500 r.p.m. Obviously such a condenser must be accurately balanced. As we shall see later, it is only at VHF that we need use a rotating condenser; there is therefore no need to discuss expedients like rotating each plate of the rotor a small amount so that the total assembly is spread out over 360 deg. A simpler solution is available. Without going into too much detail, a rotating condenser for VHF can be made to be dynamically balanced by the use of composite plates. The rotor system consists of a shaft, which will be made earthy, on which is mounted a

number of discs of bakelised linen. These are thick enough to be rigid. Shaped copper foil is stuck to the surface of these discs and soldered to the shaft. These foils form the actual rotor plates, but as their mass is small, they do not disturb the balance of the rotor. An insulating frame carrying stator plates and bearings completes the condenser. One interesting trick avoids the use of the bearings as current-carrying elements. A number of the rotor discs are completely covered with foil, and provide low-impedance connections to the motor shaft at radio frequency. These earthing discs are used as screens between signal frequency and oscillator sections of the condenser if a superheterodyne circuit is in use.

The derivation above of a practical radio spectroscope from its primitive ancestor has been parthenogenetic. For a more advanced form we must introduce a second parent. The visual alignment generator, or ganging oscillator, provides a starting point for a purely electronic radio spectroscope. As is well known, the ganging oscillator, which is used for lining up IF circuits on production lines, consists of an oscillator frequency modulated with a saw tooth or pyramid wave. The saw tooth or pyramid provides the X-deflection on a cathode ray tube, and the output of the circuit under test when the FM input is applied forms the Y-deflection. A trace of the frequency response of the circuit under test is thus presented on the tube, and effects of adjustment are seen

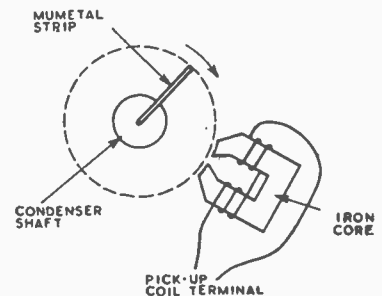

Fig. 3. Suggested synchronising pulse generator for the horizontal time base.

immediately. In practical set-ups, the circuit output is usually rectified and then amplified in a logarithmic amplifier so that a decibel scale of Y-deflection can



be used. It will be appreciated that the ganging oscillator behaves in just the same way as the frequency-changing oscillator of the radio spectroscopy described above, except that the frequency modulation is produced by the use of a reactance valve instead of by a rotating condenser. The ganging oscillator commonly swings over about 50 kc/s: this is not enough for our purpose here, and circuits providing a swing of perhaps 500 kc/s are desirable for use on the MF and HF bands. This amount of frequency modulation can be achieved at frequencies of about 10 Mc/s without much difficulty: at lower frequencies it is not easy to maintain a linear relationship between the controlling voltage, and the frequency. With a wide-range ganging oscillator the system becomes quite simple.

### The Complete Circuit

The circuit is shown in Fig. 4. A wide-band RF amplifier accepts signals over the whole band under examination, and amplifies them for application to the signal grid of the mixer valve. This amplifier, like the RF amplifier in a normal receiver, is only required if a really sensitive instrument is needed: in simple forms of the device a wide bandpass coupling may be used between aerial and signal grid. The voltage applied to the oscillator grid of the mixer is provided from the arrangement in the lower chain in Fig. 4. The swinging oscillator is designed to work at, say,  $10 \pm 0.25$  Mc/s and is driven over this range by the sawtooth generator. If the signal band to be covered extends from 500 kc/s to 1 Mc/s, an IF of 10.75 Mc/s could be used. This arrangement is rather inflexible, however. By the addition of a second oscillator of frequency  $f_2$  and mixer, any convenient frequency,  $|f_2 \pm 10| \pm 0.25$  Mc/s can be applied to the signal mixer, and there is greater freedom of choice for the intermediate frequency. Furthermore, the range of the instrument can be extended, for the input filters and second oscillator can be ganged together and the band under examination can be varied without disturbing the swinging oscillator. In practice it is often convenient to use an ordinary receiver as the IF amplifier, the whole system being then a double superhet.

By combining rotating condenser systems with electronic systems a wide variety of effects can be produced. This survey of the general properties of radio spectroscopes is no place for further discussion of these circuits for special applications.

The discussion of the principles of radio spectroscopy given above is not meant to be exhaustive: all that has been attempted is an explanation of what a radio spectroscopy is, and a general description of how it can be designed. There are some general points of interest which are not usually appreciated at first. Although a radio spectroscopy gives more information about what is going on over the whole band than does a normal receiver, the usual law of nature that you can't get something for nothing is applicable. With an ordinary receiver you can tell that the B.B.C. Home Service is on, and that a programme called "Pansies in Portland Place" is being broadcast. The radio spectroscopy will tell you that on six different carrier frequencies something is being transmitted, but it

rier. If we put in a number of carriers, we must expect less intelligence about any one of them.

### Sweep Rate

The limitation described above has other aspects. Those who have attempted to line up a filter with a very sharp cut-off, a crystal filter, for example, on a ganging oscillator circuit, will know that as the sweep rate is increased curious things happen, and the true filter response is not obtained. In the same way, if the sweep rate of a radio spectroscopy is made too high, or the IF bandwidth too narrow, the marks produced by stations begin to broaden out. It is very easy to observe this effect when a communications receiver is used as the IF amplifier in an electronic spectroscopy, as both sweep rate and bandwidth can be varied. The solution of the problem of the response of a filter to a frequency-modulated wave sweeping through the pass band is astonishingly difficult. Fortunately a good approximation to the answer can be obtained by quite simple reason-

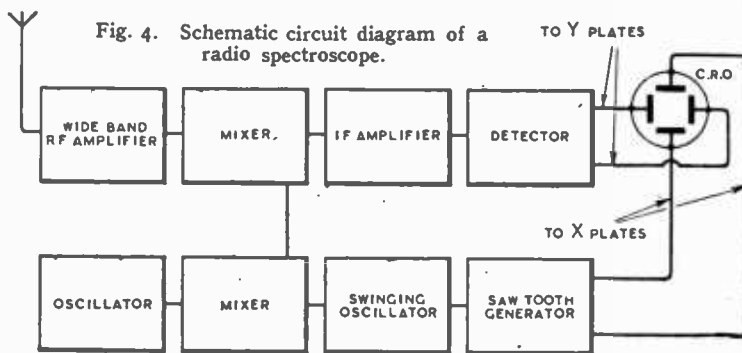

will not enable you to find out what the actual "message" part of the signal is; it may be a talk on "How to avoid dried eggs" or it may be Noel Coward; the radio spectroscopy wouldn't know and, rather wisely, couldn't care less. If the transmission is slow CW morse, then it will play, and if you can read morse, the message can be read straight from the tube face. It is quite easy to see why the apparatus behaves in this way. The bandwidth of the IF amplifier is assumed to be the normal value for a receiver. This is barely enough to cope with the intelligence radiated on one car-

ing. Two approaches are possible. Either we may say that the signal must be in tune for long enough for oscillations to build up in filter circuits of known  $Q$ , or we can adopt a more analytic approach.

Suppose that we are sweeping over a band of width  $n$  c/s,  $p$  times every second. The IF bandwidth is taken to be  $m$  c/s. If the IF amplifier and filter system is considered as split up into two halves, we can see more clearly what happens when we sweep through a station. The first stages of the IF amplifier, having a bandwidth of  $m_1$  c/s, will be swept through in  $m_1/np$

## Radio Spectroscopy—

seconds. For this length of time, then, a signal is applied usefully to the input of the first IF amplifier, and an impulse of this duration appears at the output. Experience with television amplifiers suggests that a signal lasting for  $t$  seconds requires an IF bandwidth of  $3/t$  c/s, or a vision frequency cut-off of  $3/2t$  c/s if the distortion is not to be excessive. If this experience is applied to the design of the second IF amplifier, we can see that the bandwidth of this amplifier,  $m_2$  c/s, must be such that a signal lasting for  $m_1/np$  seconds is transmitted with little distortion. The required bandwidth is  $3np/m_1$  c/s, which must therefore equal  $m_2$ . This leads to the equation  $m_1 m_2 = 3np$ , or, if  $m_1 = m_2 = m$ ,  $m^2 = 3np$ . The artificial separation into two IF amplifiers is only necessary in order to give the separation of function. We could have said in the first place something like this: when the carrier is swept through the IF amplifier, an impulse appears at the output, and this impulse lasts for  $m/np$  seconds. If the rectified shape of this impulse is good and square, anyone looking at it, without knowing how it was produced, will think that it was

an ordinary impulse of duration  $m/np$  which has passed through an IF amplifier of bandwidth  $3np/m$  c/s. We know, however, that the bandwidth was actually  $m$  c/s, and as the two views must be reconciled, we must have  $3np/m = m$ . The reasoning adopted here is not rigorous, for it overlooks the frequency modulated character of the actual signal in the IF amplifier. It does, however, give a fairly good approximation.

## 50 c/s Satisfactory

If the bandwidth is  $m$  c/s, we can just about resolve stations spaced  $m$  c/s apart, provided that the impulse is not artificially broadened by sweeping too fast. The conditions discussed above give satisfactory results, and if we wish to sweep a band  $n$  c/s wide and use an IF bandwidth of  $m$  c/s, we must have  $p = m^2/3n$  sweeps per second.

In the MF band we can take  $n = 500$  kc/s (from 1 Mc/s—300 metres to 500 kc/s—600 metres), and  $m = 10$  kc/s. This gives  $p = 67$  c/s. To provide a small safety margin a 50 c/s time-base would be used. Experiments show that this rough formula gives quite good agreement with practice.

## AMATEUR RADIO : 1905 MODEL

A REPLICA of a wireless transmitter and receiver sold for home use forty years ago was recently demonstrated in operation in New York by Hugo Gernsback, publisher of our American contemporary *Radio-craft*. As spark transmission is now forbidden, a special dispensation from the Federal Communications Commission was necessary for the occasion. In the authorisation, frequency is given rather vaguely as "above 30 Mc/s." Ultra-short waves are not so new!

The outfit, shown in the accompanying illustration, was sold at \$7.50. The transmitter, which comprised a tin, induction coil, spark gap, morse key and aerial, was powered by three dry cells. The corresponding receiver employed a coherer, de-coherer, relay and a

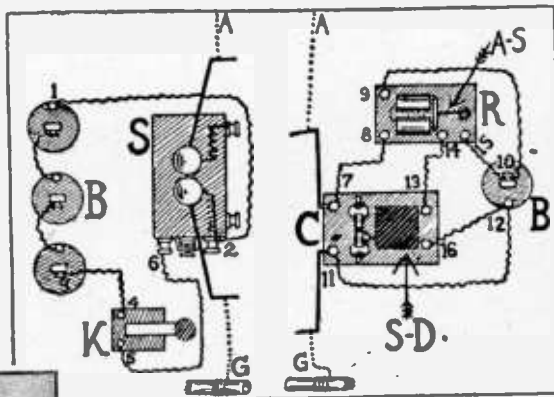

single dry cell. Signals were read from the buzzing of the de-coherer.

In the accompanying diagram, taken from the Electro Importing Company's catalogue of 1905, the reference letters have the following significance: A, aerial; G, ground; S, induction coil; B, batteries; K, morse key; R, relay; AS, adjusting spring for relay armature; SD, de-coherer; C, coherer; 8 and 9, relay magnet terminals; 7 and 11, coherer terminals; 13 and 16, de-coherer terminals; 14 and 15, relay contact terminals.

**WIRELESS TELEGRAPH**  
The "Tollmoo" Complete Outfit, comprising 1 inch Spark Coil, Ballo. Key, Coherer with Auto De-coherer and Sounder, 50 Ohm Relay, 4 Cell Dry Battery, Send and Catch Wires, and Connections, with Instructions and Diagrams. Will work up to 1 mile. Unprecedented introduction prices. Agents Wanted. Illustrated Pamphlet.

**ELECTRO IMPORTING CO., 32 Park Place, New York**

## Letters to the Editor

# Specialised Broadcast Receivers • Frequency-Changer Calculations • Hearing Aids

### Sets for Export

I HAVE just received my December *Wireless World*, and hasten to support R. W. Hallows' and "Dialist's" views on post-war broadcast receivers. I hope that their timely advice will not fall on deaf ears; also that the industry will pay greater attention to the export market.

Need I say that British radio manufacturers blundered before the war, and that India was virtually a lost market to them? Have they found out their mistakes? Here are some of them:—

1. Non-standardised usage of valves.
2. Ugly cabinets without "eye appeal."
3. Non-tropic-proof components.

Indian servicemen are not highly trained, and they like and recommend American sets for their simple and standardised arrangement of valves.

India is a poor country, and cheap receivers will be welcomed. But high-quality sets will be needed as well.

H. K. L. ARORA

New Delhi, India.

### Pubradio

FROM time to time, in order to study the advance in the science of chemistry and the degradation of my fellow man, I visit one of the establishments where alcohol in a diluted form is purveyed for immediate consumption. In these places, often termed, by their habitués, "public houses," there is sometimes a broadcast receiver. The manufacturers of these devices, while no doubt aware of the civilising mission they can perform, have, in my view, omitted certain considerations from their design. These, sir, I crave your hospitality to make known.

First I would urge that the serviceability of these machines should be increased. They have a very hard life in a warm atmosphere. Many hands assault their

controls with that lack of care which is common when handling another's possession. Yet the sets are usually only the ordinary domestic model. Small wonder that the accelerated life-test in these places causes frequent breakdowns. The effect of these breakdowns is to suggest to the regular habitués that the particular set is not very good, and that when he buys a new set to comfort his deserted wife he should avoid a "\_\_\_\_\_." It would, I think, be wise if a special "pub" model were introduced. The controls should be really robust, so that they would not fail under the strenuous conditions of public life.

If the idea of such a receiver is accepted, there is an extension worth considering. In the places where people congregate there are, on crowded nights, two problems. The broadcast programme interferes with conversation, and conversation interferes with the broadcast programme. It would be useful to have a two-position tone control. In one position a harsh strident tone would force everyone to listen to the news summary. In the other, the elimination of all high notes would produce a gentle booming background. A considerable amount of volume compression could usefully be included to maintain a constant level. Refinements and extensions of this are possible, but the basic idea is that it should be accepted that realism is not needed, nor even desirable in such circumstances. The quality should be modified to suit the environment.

Here is a new and interesting problem for the student of quality. How rarely are his studies carried out in so congenial an atmosphere! T. BUVANT.

### "Sandwich" Training

WITH reference to suggestions recently made in *Wireless World* on the alternation of technical study with periods of practical work in industry it may be

possible to learn something from current practice in Canada. In the Dominion it has long been possible for civil engineering students to take their courses from October 1st to April 30th, when outdoor construction work is stopped by the severity of the winter. During the rest of the year construction goes ahead at full blast, and students stand a good chance of obtaining a paid job.

In good times many students do this, and earn enough in the summer to pay for the following winter's tuition fees and board. The other faculties—Electrical, Mechanical and Chemical—have followed suit, so far as timing goes.

This plan is admittedly brought about by the climatic conditions prevailing in Canada, but it seems to have had three important results. First, it marries up theory and practice, and it is preferable for a student to alternate his studies and work every six months rather than, say, every few years. Secondly, it enables students to pay their way through university, thus putting the recruitment of engineers on a much broader basis than if the students were forced to rely on their parents' finances. Lastly the university authorities are enabled to insist that the student does practical engineering before he is granted a degree.

L. A. SHERWOOD.

London, S.W.1.

### Oscillator Circuit Calculations

I HAVE been very interested in some of the articles giving methods of calculating the values of padding condensers and oscillator circuit inductances which have, during the past few years, been published both in *Wireless World* and *Wireless Engineer*. They all have the disadvantage that they cannot easily be evaluated on a slide-rule, and I feel that some readers may be interested in two simple empirical formulae which give results accurate

**Letters to the Editor—**

to within 10 per cent. Some may feel that a 10 per cent. error is somewhat large, but I should like to point out that, even if accurate calculations are made, it will in practice be necessary to adjust the values during the lining-up of the receiver. Further, condensers and inductances cannot easily be obtained having tolerances of the order of 1 per cent.

The formulæ referred to are:—

$$\frac{C_p}{C_1} = \frac{\alpha^2}{A^2 - \alpha^2} \quad \dots \quad (1)$$

$$\frac{L_o}{L_s} = \left( \frac{f_1}{f_1 + IF} \right)^2 \left( \frac{C_1}{C_p} + 1 \right) \quad (2)$$

where  $C_1$  is maximum capacity of tuning condenser.

$C_p$  is padding condenser.  
 $\alpha$  is oscillator frequency ratio over entire tuning range.

$A$  is signal frequency ratio over entire tuning range.

$L_o$  is oscillator inductance.  
 $L_s$  is signal circuit inductance.

$f_1$  is lowest frequency of band.

$IF$  is intermediate frequency.

The value of the oscillator trimming condenser is not given by these formulæ as they are based on the assumption that its value is equal to that of the signal frequency circuits. This is no great disadvantage as it must always be adjusted on a signal. On the assumption quoted, the formula

obtained for  $C_p$  is  $\frac{C_p}{C_1} = \frac{\alpha^2 - 1}{A^2 - \alpha^2}$

The omission of the constant gives more accurate results, particularly on the lower frequency bands, and is therefore recommended.

H. P. STAUNTON.

Ashford, Kent.

**Hearing Aids**

RECENTLY questions have been asked in the House of Lords about hearing aids in general and plans for the manufacture of a utility aid in particular.\* These questions and subsequent reports and correspondence in the Press have given many people interested in the subject a wrong impression of the situation as a whole, especially where the different committees and their functions are concerned. May I, therefore, be allowed to

give your readers a few facts?

The following technical committees are in existence: 1. National Institute for the Deaf Medical Committee (Protection of the deaf public against inefficient aids, and unethical suppliers). 2. Medical Research Council—Electro-acoustics Research Committee (fundamental research into electro-acoustic problems). 3. British Standards Institution Committee (calibration and standardisation of audiometers). (This is quiescent at the moment.) 4. The Hearing Aid Manufacturers' Association—Technical Committee (this is in three sections: (a) Utility aid and general standardisation; (b) audiometers and hearing tests (c) technical education for the staff).

The President of the H.A.M.A. attends meetings of the N.I.D. Medical Committee. The Secretary of the N.I.D. attends most meetings of the H.A.M.A. The latter is now represented on the B.S.I. Committee. There is as yet no official contact between the M.R.C. Committee and the H.A.M.A. Technical Committee. The former Committee, however, is fully informed of the work of the latter, and closer co-operation may result.

In these days of fear of trade associations becoming cartels, it is desirable to explain about membership of the H.A.M.A. This is open to all hearing aid suppliers on the N.I.D. approved list. Any hearing aid supplier whose instruments meet with the approval of the N.I.D. Medical Committee, and who agrees to give home trials of at least one week before selling an instrument, to avoid door-to-door touting and other undignified practices, is put on the N.I.D. approved list. It is a great pity that the general Press has not given more publicity to the work of the N.I.D., for many deaf people are quite unaware of the existence of the approved list and of its significance.

From 1934 to the outbreak of the war, the hearing aid manufacturers here, with the help of British valve makers, led the world in the design and production of pocket valve amplifiers. British valve aids were exported to most foreign countries, including the U.S.A. They were much smaller and more efficient than anything available elsewhere.

Since the war, members of our Association have had a tremendous struggle to keep their instruments in operation, and to supply the users with adequate battery and other replacements. With the help of the Board of Trade we have managed reasonably well, and produced sufficient new instruments to make importation of valve aids unnecessary. Encouraged by the N.I.D. we produced the specification of a "pooled" utility three-valve pocket aid, which we were hoping to produce during the war to sell at a price around £10. We were unable, however, to obtain supplies of valves, components and batteries over and above our existing very small allocation, to make the manufacture of these utility aids possible. The situation remains unchanged.

The number of valve aids in use in Great Britain is now definitely known to be under 50,000. The total figure of deaf people who could be helped by a valve aid is undoubtedly higher, but it includes many who obstinately refuse to wear an aid. It is certain that among these potential users there are very few indeed who remain deaf because they cannot afford an aid. Before the war our members supplied robust and reliable valve aids from 8 gns. upwards. They used standard batteries and the upkeep amounted to only sixpence a week. Hospital clinics help patients to obtain aids at substantially reduced prices, and many societies give grants towards purchase.

Deafened ex-Service men are given aids free of charge by the Ministry of Pensions, with whom a number of our members have contracts. Happily, this business is negligible. The number of men recommended for hearing aids last year was officially given as 60.

ALEXANDER POLIAKOFF,  
Chairman, Technical Committee,  
H.A.M.A.

223-7, St. John Street,  
London, E.C.1.

**ELECTRICAL INSTALLATIONS**

THE "B.I. Pocket Book for Wiremen" (M.111/1), issued by British Insulated Cables, Ltd., Prescot, Lancs. gives useful information for electrical contractors on the rating of conductors, fuses and motors, extracts from the I.E.E. recommendations and notes on the testing of installations.

\* See opposite page.

# WORLD OF WIRELESS

## RADAR PATENTS

**E**STIMATING that for several years after the war there will be sales of radar equipment amounting to \$75,000,000 a year, the Director of the Electronics Division of the U.S. Navy has advocated the setting up of a radar patent pool.

When addressing a joint meeting of the American Institute of Electrical Engineers and Institute of Radio Engineers, the Director stated that there is very little information available about the number and scope of radar patent applications filed. He stressed the need for the industry to take such steps as were necessary to avoid clashes when the U.S. Patent Office released the estimated 2,000-3,000 radar specifications from the secrets list.

The proposal is for a non-profit corporation to be formed for licensing pooled radar patents.

## EMPIRE BROADCASTING

**C**ONCURRENTLY with the Commonwealth Broadcasting Conference attended by representatives of the broadcasting organisations of the Dominions and India, a Technical Sub-Committee met to discuss the engineering and scientific aspects of commonwealth broadcasting.

Although details of the findings of the Committee are not available it is learned from a statement issued by the Chairman of the Conference, W. J. Haley, B.B.C. Director-General, that "the Technical Sub-Committee has done valuable work in studying problems of improving coverage and transmission, particularly on short wavelengths; sound recording and reproduction; the collection, dissemination, and practical use of ionosphere data; studio acoustics and frequency modulated transmission."

## SECRET PACIFIC RADIO

**T**HE George Medal has been awarded to two officers, who in 1942, on the Pacific Island of Tarawa, held by the Japs, succeeded in getting information of the enemy's movements back to Allied Naval authorities, when the main transmitting station had been put out of action.

2nd Lt. R. G. Morgan, an Australian, who was in charge of a training school for native wireless operators, concealed a portable transmitter and, in spite of Japanese threats, relayed information sent to him by a system of runners by Capt. F. G. L. Holland, 60-year-old Director of Education, Gilbert Islands. Lt. Morgan, who volun-

tarily remained on the island, after arranging the escape of most of the civilians, was notified of the award by radio. He was later killed by the Japanese with 21 European prisoners.

## STANDARD FREQUENCIES

**T**HE transmissions from the U.S. National Bureau of Standards' radio station, WWV, near Washington, D.C., have been extended to include a continuous radiation on 15 Mc/s throughout the 24 hours.

Standard audio frequencies of 440 c/s and 4,000 c/s are now broadcast continuously on this carrier.

Details of the transmissions on 2.5, 5 and 10 Mc/s, which remain unaltered, were given in the September, 1944, *Wireless World*.

## OLIVER LODGE SCHOLARSHIP

**A** RESEARCH scholarship, which is to be known as the "Oliver Lodge Scholarship," has been founded by the Institution of Electrical Engineers to commemorate the 25th Jubilee of the Radio Section.

The scholarship will have a basic annual value of £250 and will be tenable for one year. The scholar will have to carry out research in a subject closely allied to radio engineering.

Further particulars and nomination forms are obtainable from the Secretary, I.E.E., Savoy Place, London, W.C.2. Nominations must be received by May 15th.

## WHAT THEY SAY

**SPOKEN WORD versus LAZY MAN.** Broadcasting has one great advantage over other methods of distributing information: it can push things at people in such a way as to overcome the barrier of inherent human laziness.—*Lord Vansittart, speaking at the Radio Industries Club on "Radio's Part in Keeping the Peace."*

**APPLIED SCIENCE.**—In this country, the advance and efficient application of science requires democratic planning largely by scientists themselves. For this we propose a Central Research and Development Council, under the authority of the Lord President of the Council.—*Clause from the resolution drafted during the recent conference on "Science in Peace" organised by the Association of Scientific Workers.*

## HEARING AIDS

**H**AVING asked in the House of Lords what progress had been made by the Medical Research Council towards the supply of standard national acoustic aids for deafened ex-Servicemen, the Duke of Montrose, President of the National Institute for the Deaf, moved that provision should be made in all large cities for setting up approved otological clinics as part of any national social rehabilitation scheme for ex-Servicemen. He said that after the last war 34,000 men were discharged because

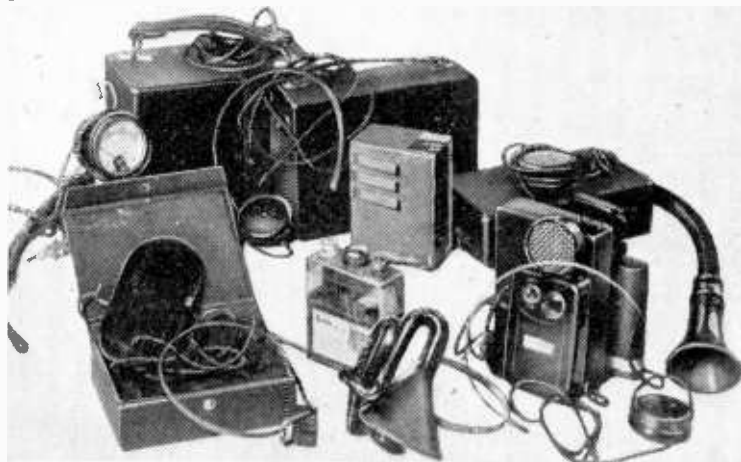

**ELECTRONIC AND ACOUSTIC** hearing aids of varying types are available, and have been supplied to British prisoners of war through the Red Cross and St. John War Organisation. Literature on the choice of a hearing aid has also been supplied to P.O.Ws.

**World of Wireless—**

of deafness, but after this war the country ought to be ready to train and treat at least 200,000 deaf cases.

There were, he said, about 20 kinds of aid for the deaf, but their prices were exorbitant. He had an offer from one firm to make 10,000 sets at £10 each, but he was sure a national standard set could be provided by mass production at £5, and distributed on a national basis.

**PERSONALITIES**

**Leslie McMichael** has been elected an honorary member of the Radio Society of Great Britain. He was a co-founder of the Society and was, at one period, Hon. Secretary.



**O. S. PUCKLE, M.I.E.E.**, who has left Cossor's Research Dept., which he joined in 1932, to become Chief Engineer and a director of R. F. Equipment Ltd., of Amersham, Bucks. He has worked on radiolocation practically from its inception and has collaborated with L. H. Bedford in work on the velocity modulation television system. He is probably best known for his work on time bases.

**Dr. E. F. W. Alexanderson** was recently awarded the Edison Medal for 1944 "for outstanding inventions and developments in the radio, transportation, marine and power fields." He has also recently received the award of the Swedish Cedergren Gold Medal. Dr. Alexanderson, who is now Consulting Engineer with the G.E.C. at Schenectady, built the original HF alternator for Prof. R. A. Fessenden, which resulted in the first broadcast of radio telephony on Christmas Eve, 1906.

**G. L. Marshall**, Northern Ireland Director of the B.B.C., has just completed 21 years' service with the Corporation. He has been in Belfast 13 years, during which time the new headquarters in Belfast and the transmitting station at Lisnagarvey have been erected.

**Dr. F. E. Terman**, well-known author of "Radio Engineering," has been appointed Dean of the Stanford University School of Engineering, Palo

Alto, California. He is at present head of the U.S. Government Radio Research Laboratory at Cambridge, Mass.

**R. J. F. Boyer** has been appointed Chairman of the Australian Broadcasting Commission in succession to J. W. Cleary.

**W. S. Verrells** has resigned from his position as Chairman and Joint Managing Director of E. K. Cole, Ltd. With a capital of only £50, he and E. K. Cole formed the Company in 1925 to manufacture mains power units. E. K. Cole continues as managing director.

**A. G. Allen, D.S.O., M.C.**, a director, has been appointed Chairman of E. K. Cole, Ltd. He was Chairman, for a year, of the Associated British Pictures Corporation.

**OBITUARY**

It is with regret we record the following death:—

**Percy W. Paget**, the last survivor of the group of pioneers associated with the first transatlantic wireless transmission in December, 1901, who died at the age of 72. He joined the Marconi Company in 1898, a year after its incorporation, and went to Newfoundland in 1901 with Marconi and G. S. Kemp to set up a receiving station for the experiments which proved the practicability of transatlantic wireless communication. Mr. Paget retired from the Marconi Company in 1938 after 40 years' service.

**IN BRIEF**

**N. Rhodesian Radio.**—A new broadcasting station was opened on March 25th at Lusaka, Northern Rhodesia. It operates daily from 5.30 to 8 p.m. on a wavelength of 76 metres. Technical and experimental work is being carried out and will be expanded when the delivery of transmitters ordered from this country is completed. One transmitter arrived in a badly damaged condition, and another is in transit.

**Sudan Broadcasting.**—To overcome poor reception in the Khartoum area it is planned to install a new short-wave 5-kW transmitter. A 20-kW medium-wave transmitter to cover the middle area of the Sudan is included in later plans.

**R.C.A.** has established a new international division and plans to build manufacturing plants in several countries.

**Wavemeters.**—A limited number of Type 605A absorption wavemeters can now be supplied from stock by Rediffusion, Ltd., Broomhill Road, London, S.W.18. Eight interchangeable coils give a wide range of 7 to 3,000 metres.

**Four Officials** from the Canadian Marconi Company and Cable and Wireless have come to this country to discuss with C. and W. Head Office the development of means of communication, especially Press traffic, between Britain and Canada.

**Sign of the Times.**—175 students, all technical employees of Columbia Broadcasting System, have commenced a 60-week training course in the operation of television studio and transmitter equipment. The course, which has been developed jointly by representatives of New York University, the Columbia network and the International Brother-

hood of Electrical Workers, is in three parts, as follows:—(I) "Electrical Circuit Theory for Television," (II) "Vacuum Tube and Communications Network Theory," (III) "Television Theory and Practice."

**School Broadcasting.**—Among the provisions made by the Minister of Education under the 1944 Education Act, which came into operation on April 1st, is the equipment of all schools for broadcast reception.

**Leicester Radio Society** has been successfully restarted and the following meetings are planned:—On May 1st, a talk on "Output Valves, Curves and Load Lines" by J. C. Easter will be followed by a discussion. "Resistance/Capacity Oscillators" is the subject of a lecture to be given on May 15th by S. May. Both meetings will commence at 7.15 at the Charles Street United Baptist Chapel (side entrance), Leicester.

**MEETINGS****Institution of Electrical Engineers**

**Radio Section.**—"Notes on the Stabilities of LC Oscillators," by N. Lea, B.Sc., May 2nd.

"The Characteristics of Luminescent Materials for Cathode-Ray Tubes," discussion to be opened by C. G. A. Hill, B.Sc., May 15th.

"Non-Ferrous Contact Springs," discussion to be opened by H. G. Taylor, D.Sc.(Eng.), and L. B. Hunt, Ph.D., M.Sc. May 22nd.

All the above meetings will be held at 5.30 at the I.E.E., Savoy Place, Victoria Embankment, London, W.C.2  
**Cambridge Radio Group.**—"Carrier Protection on Overhead Transmission



**ALFRED CLARK**, Chairman of E.M.I., who has been elected first President of the Radio Industry Council. This photograph is of part of a painting by Professor Artur Pan recently presented to Mr. Clark by his co-directors. He began his career in Edison's Laboratories fifty years ago and was responsible for the building of H.M.V.



Lines," by D. H. Towns, B.Sc., at 6.0 at the Technical School, Collier Road, Cambridge, May 8th.

South Midland Radio Group.—"High Frequency Dielectric Materials," by Prof. Willis Jackson, D.Sc., D.Phil., at 6.0 at the James Watt Institute, Great Charles Street, Birmingham, April 30th.

London Students' Section.—"Education and Training for Engineers," and "Part-Time Further Education," dis-

cussion on these reports (prepared by Post-War Planning Committee) at 7.0 at the I.E.E., Savoy Place, London, W.C.2, on May 1st.

Television Society  
"Beam Tetrodes," by S. Rodda, B.Sc., at 6.0 at the I.E.E., London, W.C.2, April 27th.

Inst. of Musical Instrument Technology  
Electronic Music Group.—"A Homophonic or Single-Note Electronic

Musical Instrument with a Photo Electric Cell as Playing Manual," demonstration and lecture by Dr. W. Saraga, at 3.0 at the Northern Polytechnic, Holloway, London, N.7, on May 12th.

Royal Society of Arts

"Wire Broadcasting," by Paul Adorjan, at 1.45 at the Royal Society of Arts, John Adam Street, Adelphi, London, W.C.2, on May 23rd.

## NEWS IN ENGLISH FROM ABROAD

Country : Station	Mc/s	Metres	Daily Bulletins (BDST)	Country : Station	Mc/s	Metres	Daily Bulletins (BDST)
<b>America</b>				<b>India (contd.)</b>	9.630	31.15	1400, 1650
WOOW (Wayne) ..	7.820	38.36	0000		11.760	25.51	0900
WRUW (Boston) ..	9.570	31.34	2300		11.830	25.36	0900
WLWO (Cincinnati) ..	9.590	31.28	2300	<b>Iran</b>			
WLWR1 (Cincinnati) ..	9.750	30.77	0000, 1600*, 1730, 2300	EQB (Teheran) ..	6.155	48.74	2325
WNRA (New York) ..	9.855	30.43	0000	<b>Mozambique</b>			
WLWK (Cincinnati) ..	11.710	25.02	1600*, 1730, 2300	CR7BE (Lourenco Marques) ..	9.830	30.52	2150
WRUW (Boston) ..	11.730	25.57	1730, 2300	<b>Newfoundland</b>			
WRUS (Boston) ..	11.790	25.44	1600	VONH (St. John's) ..	5.970	50.25	2415
WCRC (Brentwood) ..	11.830	25.36	1545, 1600*, 2300	<b>Palestine</b>			
WGEA (Schenectady) ..	11.847	25.32	1500, 1730	Jerusalem ..	11.750	25.53	1715
WOOW (Wayne) ..	11.870	25.27	0000, 1600*, 1730, 2300	<b>Portugal</b>			
WNRI (New York) ..	13.050	22.99	1500, 1730, 2300	CSW6 (Lisbon) ..	11.040	27.17	2100
WNRX (New York) ..	14.560	20.60	1500, 1730	<b>Spain</b>			
WNBI (New York) ..	15.150	19.80	1500	EAQ (Aranjuez) ..	9.860	30.43	2150†
WOOC (Wayne) ..	15.190	19.75	1600*, 1730, 2300	<b>Sweden</b>			
WBOS (Boston) ..	15.210	19.72	1500	SBU (Motala) ..	9.535	31.46	2320
WLWO (Cincinnati) ..	15.250	19.67	1600*, 1730	SBP ..	11.705	25.63	1800
WCBX (Brentwood) ..	15.270	19.65	1545, 1600*, 1730	<b>Switzerland</b>			
WGEA (Schenectady) ..	15.330	19.57	1730, 2300	HER3 (Schwarzenburg) ..	6.345	47.28	2150
WRUA (Boston) ..	15.350	19.54	1415, 1545, 1600*	HER4 ..	11.775	25.48	2150
WLWL1 (Cincinnati) ..	17.955	16.70	1500	Berne ..	10.340	29.00	0300, 2150
WRUW (Boston) ..	17.750	16.90	1730	<b>Syria</b>			
WRCA (New York) ..	17.780	16.87	1500, 1730	FXE (Beirut) ..	8.035	37.34	1735
WCBN (Brentwood) ..	17.830	16.83	1545, 1600*, 1730	<b>Turkey</b>			
WNRA (New York) ..	18.160	16.52	1500, 1730	TAP (Ankara) ..	9.465	31.70	1845
<b>Australia</b>				<b>U.S.S.R.</b>			
VLG (Melbourne) ..	9.580	31.32	1635	Moscow ..	6.230	48.15	0115, 1900, 2000, 2100, 2300
VLC6 (Shepperton) ..	9.610	31.22	1600, 1635, 1700		6.770	44.30	0047, 0115
VLC2 (Shepperton) ..	9.680	30.99	1815		6.980	42.98	0115
VLG3 (Melbourne) ..	11.710	25.62	1700		7.300	41.10	0000, 0047, 0115, 0200, 0300, 1900, 2000, 2100, 2200, 2300
VLG5 (Melbourne) ..	11.880	25.25	1815		9.480	31.65	0200, 0300
<b>Belgian Congo</b>					10.445	28.72	0830, 1340
Leopoldville ..	15.167	19.78	1300		11.034	25.79	1340
<b>Brazil</b>					11.830	25.36	0115, 1300, 1340, 1420, 1800
PRL8 (Rio de Janeiro) ..	11.715	25.61	2130†		11.950	25.11	0115, 0200, 0300
<b>Canada</b>					12.260	24.47	1320†, 1700
CHTA (Sackville) ..	15.220	19.71	1345, 1545*, 1745, 1945		15.530	19.32	0115, 1300, 1340, 1420
<b>China</b>				<b>Vatican City</b>			
XGOY (Chungking) ..	9.635	31.14	1500, 1600, 1700	HVJ ..	6.190	48.47	2115
<b>Ecuador</b>					9.550	31.41	2115
HCJB (Quito) ..	12.455	24.09	0100, 2130	<b>Athlone</b> ..			
<b>Egypt</b>					kc/s	Metres	
Cairo ..	7.510	39.94	1945, 2200		565	531	1440, 1945, 2300*, 2310†
Forces Broadcasting Service ..	7.22	41.55	1030, 1330, 1930, 2200				
<b>French Equatorial Africa</b>							
FZI (Brazzaville) ..	11.970	25.06	2045, 2245				
<b>India</b>							
Delhi ..	6.190	48.47	0900, 1650				
	7.240	41.44	1650				
	7.290	41.15	0900, 1400, 1650				

It should be noted that the times are BDST—two hours ahead of GMT.

\* Sundays only.

† Sundays excepted.

# COLOUR TELEVISION

## *Discussion on Ways and Means*

IN opening an informal discussion on colour television before the Radio Section of the I.E.E., L. C. Jesty introduced the subject by saying that it seemed inevitable that a colour television service would ultimately be established. Development should be directed towards (a) the agreement of the technical methods to be employed, particularly with regard to the colour analysis and synthesis of the picture, and (b) the standard of definition to be achieved before colour is introduced.

With regard to (a), the literature shows that the methods proposed for colour television have followed logically the same steps as already trodden in colour photography and cinematography, but have not yet reached an equivalent of the elegant solution to the photographic problem known as the "subtractive integral tri-pack" technique. Television, however, being electronic and therefore practically inertialess and instantaneous, enables the older "additive" principles to be used more advantageously than in cinematography.

All the demonstrations of colour television so far given, by Baird in this country, and Bell Telephone and C.B.S. in America, have employed scanning processes embodying various colour sequences for analysis and synthesis. It is now taken for granted that the science of colour has established the necessity for a minimum of three primary colours for acceptable reproduction.

Scanning sequences can be classified under three heads: (1) Scanning each picture point; (2) scanning each picture line; and (3) scanning each picture frame, in the three primary colours. Of these (1) is the most attractive but the most difficult. It gives the minimum of difficulty in colour registration and fringing; allows the retention of the same basic scanning frequencies (line and frame) as the equivalent definition black-and-white picture;

and allows the possibility of adding colour to an existing black-and-white system, the existing receivers continuing to receive the picture in black and white. The difficulties with this system lie in changing the colour of the scanning spot at about three times the maximum video frequency of the black-and-white picture and in maintaining colour synchronism. At the other extreme (3) offers the simplification of changing the colours at only about three times the equivalent black-and-white frame frequency, but at the expense of three times the frame and line frequencies; it also suffers from the inability to add colour to an existing black-and-white system.

### Additive Systems

Various methods from "reseau" screens to moving filters have been proposed for producing the necessary primary colours. All additive colour systems result in a loss of sensitivity in the transmitter camera and loss of brightness in the received picture. These must be restored by improvements in cameras and cathode-ray tubes. Additive systems fall into two main classes: those employing optical or electron-optical superposition of the colour images, and those employing sequential projection or scanning of the colours. The former suffer from errors of superposition of the images, giving colour fringes where the registration is inaccurate, but offer the possibility of using separate channels for each colour with corresponding advantage. The latter suffer from colour fringes on moving objects, owing to the time lapse between the presentation of the successive colours, but these lags can be made imperceptible provided the colour sequence is fast enough.

Electronic scanners give high relative accuracy in the location of picture points, but absolute accuracy is of a low order. Their use for the former method is

therefore ruled out unless some auxiliary device is used for ensuring registration. The same argument applies to the use of a fixed "reseau" with either scanning sequences (1) and (2) above.

It would appear, therefore, that the only immediately practicable system is the "sequential-colour frame-scanning" system (3) (above), unless some unpublished device has been perfected, such as a method of altering the colour of a fluorescent screen at will, or receiver picture storage, or the simultaneous transmission of all picture points instead of scanning.

With regard to the standard of definition, the additional information to be conveyed in a colour picture results in an increase in the video band-width of about three times compared with the equivalent definition black-and-white picture. In going from a black-and-white to a colour picture with the same available band-width, it follows that the black-and-white picture will have about three times the number of lines of the colour picture. At low definition this would be very noticeable, but in the region of 400 lines or over the comparison in definition would become less obvious. A 405-line colour picture would require about three times the video band-width, and with vestigial sideband transmission about twice the ether space of the pre-war 405-line transmission. On this basis, a 500-600-line colour picture is not inconceivable as a long-term development. Should it be demonstrated, however, that higher definition, say, 800-1,000 lines, is necessary on purely visual grounds, then it would seem that colour television is only a remote possibility until much greater experience of the higher transmission-frequency bands has been obtained.

During the course of his remarks, Mr. Jesty gave demonstrations of the synthesis of white light from three primary colours. Sequential illumination of a set of snooker balls through a rotating

three-colour filter served to show brilliant colour fringes when the balls were set in motion. Finally, the meeting was given the opportunity of comparing monochromatic and colour cine films of the same subjects projected simultaneously side by side.

In the discussion which followed, several speakers commented on the apparent improvement in contrast in the colour pictures, and it was agreed that less range of tone was required in colour than in a black-and-white system. On the other hand, the brightness level of an additive colour television picture would be less than that of monochrome, and there was need for further development to increase the efficiency of screen fluorescence. One speaker thought that a mechanical system of scanning might provide a solution; small high-speed motors were now available with a useful life of the order of 4,000 hours.

### Colour Fringing

Colour fringing on moving objects was a serious defect of present frame-by-frame scanning methods. It could also be caused by hum in the receiver if the vertical scanning rate were not an integral multiple of the mains frequency and by fading in a propagation system depending on a network of radio links. Point-by-point scanning must be the ultimate goal, and one method by which this might be reached was to introduce transverse velocity modulation in the time base so that the wanted colour in each point would receive a longer period of illumination.

In a written communication, J. L. Baird expressed the opinion that point-by-point scanning did not offer sufficient advantages over line-by-line scanning to counterbalance the increased difficulties involved. With present frame-by-frame scanning methods a considerable reduction in colour flicker was obtained by increasing the number of interlacings (and consequently the frame frequency) for the same number of lines. He thought it rather misleading to state that frame-by-frame scanning could not be added to existing black-and-white systems. A two-colour 600-line system (200-line frames at a frame frequency of 50 per sec., interlaced three

times) could be used in the pre-war B.B.C. 405-line system, and would be received as a 200-line black-and-white picture on existing receivers. A three-colour system was necessary for accurate colour reproduction, but, in his view, a two-colour system gave a pleasing and acceptable picture.

Other speakers held that colour reproduction should not be attempted until adequate definition was assured, and that the problem of colour should be set as a separate objective, not as an adjunct to existing systems.

In his concluding remarks, the chairman (H. L. Kirke) said colour television was not likely to become an established service for some years, but when it did it would be of great value, as there were many subjects which could not be adequately portrayed in monochrome. From the æsthetic point of view he thought the subtle improvement over black-and-white of pictures with ordinary sober colours was of greater value than the more striking effects of vivid colours.

### BETRO

WITH the primary object of studying overseas markets, the British Export Trade Research Organisation has recently been formed. Among those industrial concerns which have taken part in the formation of "Betro" are several wireless and allied companies; these include the General Electric Company, the Automatic Telephone and Electric Company, British Insulated Cables, Marconi's Wireless Telegraph Company, and Cable and Wireless. Our publishers, the Iliffe group of companies, have applied for founder membership.

Betro's staffs will investigate on the spot such matters as overseas consumers' tastes and requirements, the special characteristics of each market, methods of marketing, transport and distribution, trade customs and local government regulations affecting trade.

Betro is to be registered as a company limited by guarantee and operating under Board of Trade licence. It will be non-profit-making, and revenue will be derived from membership subscriptions and payments for special investigations carried out for individual members. Full particulars can be obtained from the organiser, Philip Scott, Betro, Georgian House, Bury Street, St. James's, London, S.W.1.



### THE TANNOY LOUDSPEAKER SOUND SYSTEMS

save valuable executive time, increase production, and ensure greater general efficiency.

Remember, too,

TANNOY  
HIRE  
MAINTENANCE

ensures equipment being always at 'concert pitch.'

# TANNOY

The Sound People

TANNOY is the registered trade mark of equipment manufactured by

**GUY R. FOUNTAIN LTD.**  
CANTERBURY GROVE, WEST NORWOOD,  
LONDON, S.E.27 and BRANCHES

'Phone: GIPsy Hill 1131.

The Largest Organisation in Great Britain specialising solely in Sound Equipment

# RANDOM RADIATIONS

By "DIALLIST"

## Back in the News

HOW good it is to read in one's daily paper of the capture or liberation of place after place that we used to know so well in the days before the war when we twiddled our tuning knobs in search of entertainment from abroad—or just for the pleasure of logging stations. Poznan, Eindhoven, Kaiserslautern, Cologne, Danzig, Moravska-Ostrava, Karlsruhe, Graz, Cassel, Stettin, are just a few that have come to mind in the few days before this is written; doubtless there will be many more before it appears in print. I fear, though, that it may be some time before we have the actual transmissions of stations in Poland, Czechoslovakia, Holland and Northern Italy. Some have been badly damaged by Allied bombardment, whilst many more were badly smashed up by the routed Germans before they left. And there are stations that I hope we shall never hear again. In the bad old days Europe had far too many. No doubt with an eye to coming events the aggressor nations grabbed much more than their fair share of the long-, medium- and short-wave channels in the years before the war, and not a few of their stations were used mainly for propaganda purposes.

## Dx and Geography

To follow this world-wide war intelligently a considerable knowledge of geography is needed. Day by day the news tells of doings in the far corners of the earth and ordinary mortals must reach for the atlas to discover the whereabouts of Bandoeng or Luzon or Tandjongpriok or Suva. Not so the pre-war short-wave enthusiast. To him they are familiar names and he knows where they are without having to refer to maps. Medium-wave long-distance wireless experience came in equally useful during the North African and Italian campaigns, during the Russian advance and during the stirring doings in Western Europe that have continued since the Normandy landing. To adopt long-distance wireless as a hobby means automatically the subsequent acquiring of a useful knowledge of world geography without tears—a sound reason for encouraging any of the young hopefuls who show signs of taking it up! Apart, too, from giving them a knowledge of where

towns and countries are, it is an incentive to regard spherical trigonometry not as a mere dry-as-dust subject, but as a ready aid to the solution of a variety of interesting practical problems.

□ □ □

## Sorting Out the Channels

HOW long, I wonder, will it be after the end of the war before a European broadcasting conference assembles to evolve the new wavelength plan? The sooner the better, for the quicker they get to work the better will be their chance of producing a scheme acceptable to all. If nations are allowed to take their own course for some time before a conference is convened many difficulties will arise. New and powerful stations will be built in large numbers and each will claim to have established its right to a channel. But if this thing is tackled right soon each country can receive its allotment of channels before new stations have been erected or old ones repaired. I very much hope that whatever conference there may be will resolve right away that a 10-kilocycle separation between channels is the only thing that will answer. A system on that basis has worked and worked well for years in the United States. It makes for much less interference between stations and it has another great advantage: your channels can be known (and indicated on receiver tuning dials) by consecutive numbers corresponding to tens of kilocycles. Thus 550 kc/s is channel 55, 540 kc/s is channel 54 and so on.

□ □ □

## Should Television Pay Its Way?

THE Television Committee has recommended that television should stand as soon as possible on its own financial feet. In other words, they urge that those who derive entertainment in their homes from the television programmes should provide the money for them by paying an extra licence fee—£1 a year is suggested. At first sight that seems very right and proper—but is it really? Personally, I dislike the sharp distinction drawn between sound-only and sound-and-vision broadcasting; I should like to see the two included under the one heading of broadcast entertainment. Be that as it may, your ros. licence does not automatically entitle you to have entertainment laid

on any more than a gun or game licence provides you with the right to shoot over land. Read its conditions if you don't believe me. The Government does, in fact, maintain a broadcasting service, but you'd have to pay the same ten bob if you used your set only for receiving (in peacetime) the Air Ministry weather reports or the signals of the radio beacons. Every ciné goer will have the benefit of some, at any rate, of the television programmes when the high-definition service is in being, and why should the owner of a television pay for his fun? In any event, the cost of the post-war television programmes is estimated at an annual £1,500,000, and the best way of bringing the number of television set owners up to 1½ millions in quick time is emphatically not to impose a £1 tax on them.

□ □ □

## Fine Work

TO me one of the most amazing things about radiolocation gear is the way in which it enables semi-skilled operators to make minute measurements of almost incredible accuracy. Still more astonishing perhaps is the fact that they make such measurements without realising that they are doing anything of the kind. Here's an example. I'm not going to say to what degree of accuracy a range can be obtained, but let's suppose that it is required to measure a particular range with a maximum error of *plus* or *minus* 200 yards. The round figure speed of radio waves is 300,000,000 metres a second: more accurately it is  $2.9982 \times 10^8$  m/sec. or  $3.2772 \times 10^8$  yards per second. As Dr. Smith-Rose explained recently in *Wireless World*, ranges are measured by timing the out-and-home journey of pulses, so that 1,000 yards of range equals 2,000 yards of pulse travel, if I may so put it. A moment's work on the back of an old envelope will show that a pulse returns from a "target" 1,000 yards away in 6.1 microseconds. As 6.1  $\mu$ -sec. represents 1,000 yards of range, 1.22  $\mu$ -sec. corresponds to 200 yards. And being accurate within such limits is, I think you'll agree, pretty fine work! Not very wonderful in the laboratory, perhaps with a skilled physicist at work; but something of an achievement on the battlefield, especially when the work is done by an operator who, in civil life, may never have made measurements more accurate than the pint

of beer, the pound of butter or the yard of cloth of everyday life.

□ □ □

### High-fidelity Sound

IT was not, perhaps, surprising that the Television Committee made scant reference in its report to the sound transmissions from television broadcasting stations. The members no doubt felt that the vision side of the business was their particular affair and stuck to that. I can't help wishing at the same time that they had recommended that high-fidelity sound transmissions should take place throughout ordinary programme hours, whether or not vision was being sent out. As they didn't do so, I hope that the Television Advisory Committee will. The "pros" are many and important; the "cons," so far as I can see, nil. First, it would give all who invested in good televisions every opportunity of making full use of them. People may be rather chary about buying apparatus that can be used for only an hour or two a day, but many would be anything but reluctant if they knew that their television set's sound department could be used at any time to bring in, say, the national programme far better than any ordinary domestic wireless receiver could. Then there's the amateur experimenter, keen on the quality aspect of wireless reception. A splendid field would be opened to him and he could be relied upon to make full use of it. And apart from the amateur, there is the professional radio engineer specialising in the matter of fine reproduction. We owe a great deal to him already for the wonders that he has worked in the reproduction of ordinary sound broadcasting; our debt would be greater still if high-fidelity broadcasts of the complete programmes gave him a chance of showing what he could do with them. There was, so far as I recall, no mention of FM in the report. I want to see us going ahead with FM, largely because I feel that it offers one of the best hopes of palliating interference. I'm afraid that the Television Committee's recommendation that the Postmaster-General should be given powers to enforce the suppression of radiated interference won't get us anywhere—at any rate for a very long time. There will be far too much opposition from vested interests.

#### GOODS FOR EXPORT

The fact that goods made of raw materials in short supply owing to war conditions are advertised in this journal should not be taken as an indication that they are necessarily available for export.

## Wireless World

### THE "SONIGAGE"

#### Supersonic Sound Measurement of Metal Thickness

IN many instances in aircraft construction, for example, hollow metal propeller blades, a surface finishing operation has to be carried out on a totally enclosed hollow structure which may reduce the thickness of the material beyond the safety point. The inaccessibility of the inner surface precludes the use of normal gauges and a method must be devised by which the thickness can be measured from the outer surface without drilling or cutting.

In the "Sonigage," an instrument designed by the Research Laboratories Division of the General Motors Corporation and described by W. S. Erwin in a paper before the Society of Automobile Engineers (October, 1944), supersonic sound waves are excited in the material by a thin quartz plate silvered on one side and using the work as the other electrode. Piezoelectric vibration is induced by an oscillator and resonance conditions are indicated by the power absorbed from the oscillator circuit. Standing waves are established between the front and back surfaces of the metal, and, for the fundamental mode, the thickness  $t$  in thousandths of an inch is given by the relation  $t = c/2f$  where  $c$  = velocity of sound in the material in inches per second, and  $f$  = resonant frequency in kilocycles.

Good contact with the work is essential and this is achieved by brushing the surface with oil before applying the crystal unit. The natural frequency of the latter must be above the range of the oscillator.

The "Sonigage" has two frequency ranges covering thicknesses in steel, from 0.002 to 0.4 inch and the maximum error does not exceed 2 per cent.

#### CATALOGUES RECEIVED

INTERIM catalogue No. 256 (Jan., 1945) describing standard capacitor types made by A. H. Hunt, Ltd., Bendon Valley, Garratt Lane, London, S.W.18. Circulation limited to set designers and manufacturers.

Descriptive List N.S.C.12—"B.I. Radio Frequency Cables," from British Insulated Cables, Ltd., Prescott, Lancs.

Leaflet No. 18 describing metallised ceramic bushes for hermetic seals, issued by Steatite and Porcelain Products, Ltd., Stourport-on-Severn, Worcs.

Illustrated brochure describing the applications of the "Clayflex Flexible Bearing" from Clayflex, Ltd., Tiddington Road, Stratford-on-Avon.



#### THE "FLUXITE QUINS" AT WORK

"Do you call that an EARTH?" chuckled EE.  
"It's FLUXITED nicely, I see,  
but when OO sees it, lad,  
there'll be trouble, bedad,  
It's her bath! I should hop it, tout suite."

See that FLUXITE is always by you—in the house—garage—workshop—wherever speedy soldering is needed. Used for over 30 years in Government works and by leading engineers and manufacturers. Of all Iron-mongers—in tins, 8d., 1/4 & 2/8.

Ask to see the FLUXITE POCKET BLOW LAMP. Price 2/6.

TO CYCLISTS! Your wheels will NOT keep round and true unless the spokes are tied with fine wire at the crossings AND SOLDERED. This makes a much stronger wheel. It's simple—with FLUXITE—but IMPORTANT.

The FLUXITE GUN puts FLUXITE where you want it by a simple pressure. Price 1/6, or filled, 2/6.



ALL MECHANICS WILL HAVE

# FLUXITE

IT SIMPLIFIES ALL SOLDERING

Write for Book on the ART OF "SOFT" SOLDERING and for Leaflets on CASE-HARDENING STEEL and TEMPERING TOOLS with FLUXITE. Prices 1d. each.

FLUXITE LTD.

(Dept. W.W.), Bermondsey Street, S.E.1

# RECENT INVENTIONS

## SUPER-REGENERATIVE RECEIVER

AN electron tube is arranged to develop two frequencies, one by velocity modulation and the other by back-coupling two of the electrodes. The second frequency is then used to "quench" the first, as in a super-regenerative receiver.

The velocity-modulating electrode comprises two concentric cylinders M, M<sub>1</sub> situated between the control grid G of the cathode K and the anode or plate P of the tube. Incoming signals are fed by a loop L to a coaxial-line resonator T, which is branched across the two concentric cylinders of the modulator, so that the RF fields "bunch" or velocity-modulate the electron stream as it passes through.

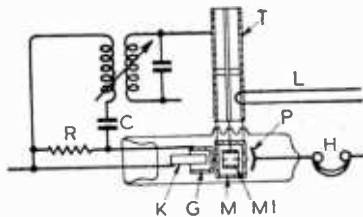

Super-regenerative receiver for high frequencies.

Meanwhile the outer conductor of the resonator feeds back energy to the control grid through a coupling circuit, which includes a blocking condenser C and a leak resistance R, to generate a quenching frequency. The resulting signals are heard in a pair of headphones H.

Marconi's Wireless Telegraph Co., Ltd., and G. B. Banks. Application date May 9th, 1941. No. 564731.

## INDICATING FIELD STRENGTH

A RELAY responding automatically to waves of a given amplitude is used for plotting the polar diagram of a short-wave transmitting aerial. The device includes a reactance winding, having a core of high permeability, and connected across an AC source. The magnetisation of the core is controlled by two coils arranged in opposition. One coil takes the anode current from a pentode valve coupled to a stationary receiving dipole, whilst the other coil is fed with a steady direct current. For a given value of the latter, it follows that the core will be de-saturated when the grid of the pentode reaches a certain potential due to the energy fed to it from the dipole, that is, for a given strength of the prevailing field. The resulting sudden change of potential across the reactance then operates the relay.

A number of such relays, graded to respond to different field-strengths, are arranged at selected points around the transmitter, the orientation of which is then varied, step by step. By linking the relays with a flashlamp at the

## A Selection of the More Interesting Radio Developments

transmitter, a photographic record can be taken of the corresponding field-strength contours.

The British Thomson-Houston Co., Ltd., and J. Dyson. Application date April 30th, 1943. No. 563698.

## - COLOUR TELEVISION

A COMPOSITE fluorescent screen for producing, say, a two-colour picture in a cathode-ray receiver consists of a stack of mutually insulated conducting strips, laid face to face, the exposed edges of the long sides forming the active surface. Before assembly, the edges are coated with different fluorescent material, and the stack is arranged so that lines of blue-responsive zinc sulphide alternate with lines of orange-responsive zinc cadmium sulphide. Each set of similarly coated strips is electrically bonded to a separate bus-bar arranged at opposite ends of the stack, the bus-bars being fed with a square-shaped voltage which is synchronised with the frame-scanning frequency.

The incidence of the scanning beam is determined by the relative potential of the two intermeshed network of strips, so that the lines of one colour are first completely scanned, and then those of the second colour, and so on.

A. C. Cossor, Ltd.; D. A. Bell; and H. Moss. Application date May 4th, 1943. No. 565547.

## TELEVISION SCREENS

IT is usual to mask the fluorescent screen of a CR tube in order to hide the ragged edges of the scanning raster. This practice, however, has certain drawbacks. An external mask, for instance, limits the size of the picture when viewed at an angle, whilst any mask is liable to produce undesirable reflection.

The invention discloses a method of laying a fluorescent screen of the required size and shape, with clear-cut edges, on the inside of the bulb, in such a way that the borders consist only of transparent glass, against which any irregularity in the raster cannot be seen. A disc of filter paper, with a centre aperture of the required size, is first laid over the inside of the glass bulb, and is moistened so that it adheres closely. A binding material is next applied to the exposed glass surface, on which the fluorescent coating is laid, say, by the "air-setting" method. When dried by an air jet, the filter paper will fall away, leaving the screen *in situ*.

Philco Radio and Television Corporation. (Assignees of J. S. Vansant.) Convention date (U.S.A.) March 30th, 1942. No. 564425.

## TELEVISION AND SOUND SIGNALS

RELATES to systems of the kind in which the sound accompanying a television programme is transmitted in the form of a series of pulses of constant width but varying amplitude, which are superposed on the common carrier wave, together with the synchronising impulses, during the line-blanking periods when the picture signals are suppressed.

According to the invention, the system is modified by varying the width of the sound-carrying pulses in such a way that changes in width represent the depth of modulation, whilst the rate-of-change of width carries the tonal frequencies. The amplitude of each pulse can thus be kept constant. One advantage of the modified system is that the peak level of the sound pulses can be used to control the gain of the set, instead of having to introduce auxiliary pulses for this purpose. Another is that the amplitude of the sound pulses can be made substantially greater than either the picture or synchronising signals, whereby all three are more easily separated in the receiver. If desired, the usual synchronising impulses can be width-modulated to carry sound, thus making the one set of pulses serve both purposes.

S. R. R. Kharbanda and Pye, Ltd. Application date January 7th, 1943. No. 564511.

## ELECTRONIC RELAYS

THE drawing shows a relay of the kind in which an electron stream is deflected by impulses from a source S so as to fall on one or other of two targets A<sub>1</sub>, A<sub>2</sub>, these being connected to output loads R<sub>1</sub>, R<sub>2</sub> respectively. A strong signal, however, is liable to swing the beam too much to one side of the centre line, so that some or all of the electrons fail to strike against the proper target, thus giving weak or false indications.

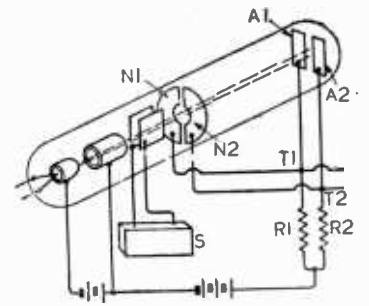

Beam deflection relay.

To prevent this, two intercepting electrodes N<sub>1</sub>, N<sub>2</sub> are placed close behind the usual deflecting plates in order to catch any electrons that are over-deflected. They are connected to T<sub>1</sub>, T<sub>2</sub> to the load resistances, so that their pick-up is added to that of the main target. The interceptors are cut



away at the centre to allow a normally deflected beam to pass freely. One advantage of the arrangement is that the main targets can be made smaller than usual, thus reducing the overall size of the tube.

H. Ziebolz. Convention date (U.S.A.) April 22nd, 1942. No. 564382.

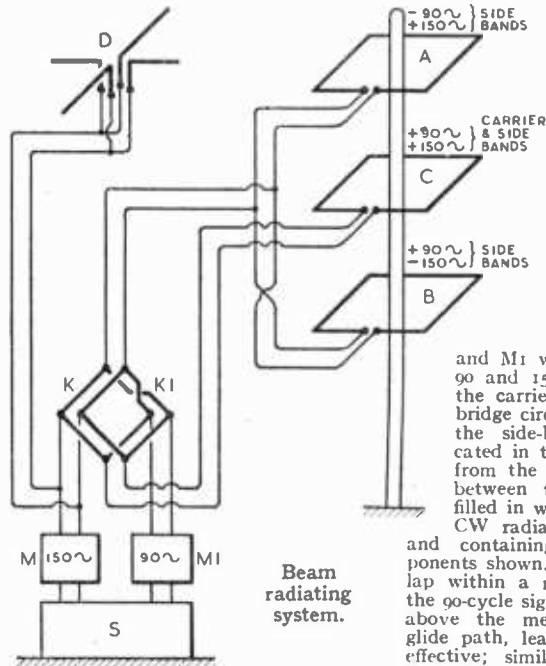

**VOLTAGE STABILISERS**

CASUAL fluctuations in a DC supply are offset by a regulating circuit which includes two local oscillators, one being a piezo-crystal of constant frequency, and the other a valve generating a frequency which varies with the supply voltage.

A reactance coil, shunted across the supply terminals, responds to any voltage variation by a change of inductance, which in turn alters the frequency of the valve generator, and so affects the difference frequency obtained by mixing the valve output with that from the crystal oscillator. The output from the mixer is fed to a discriminator circuit, which develops a control voltage that is of the same polarity whether the supply voltage rises or falls. This is applied as a correcting bias to the control grid of a low-impedance valve, which is inserted between the positive supply terminal and the load to make the system self-regulating.

G. S. P. Scantlebury. Application date March 27th, 1943. No. 566031.

The British abstracts published here are prepared with the permission of the Controller of H.M. Stationery Office, from specifications obtainable at the Patent Office, 25, Southampton Buildings, London, W.C.2, price 1/- each.

**BLIND LANDING SYSTEMS**

A NUMBER of overlapping beams are arranged to give a clear-cut gliding path which is as free as possible from false or ambiguous indications. This is secured by first radiating two relatively fixed beams, separated by a narrow gap which contains no energy, and then filling this gap with a third beam suitably modulated with course-indicating signals.

The distance between the two aerials A and B is adjusted so that the radiation field from the pair includes two closely adjacent major lobes, in opposite phase. Radio-frequency from the source S is modulated at M and MI with two signal notes of 90 and 150 c/s respectively, and the carrier-wave is suppressed in bridge circuits K, K1 so that only the side-band components indicated in the drawing are radiated from the aerials A, B. The gap between the two lobes is then filled in with a lobe of modulated CW radiated from the aerial C, and containing the side-band components shown. All three beams overlap within a narrow region in which the 90-cycle signal note is cancelled out above the median line forming the glide path, leaving the 150-cycle note effective; similarly, only the 90-cycle note is heard below this line.

False indications are eliminated by radiating the side-bands of only one of the signal notes from a separate vertically directive aerial D, which covers the region above the glide path.

Standard Telephones and Cables, Ltd. (assignees of A. G. Kandoian). Convention date (U.S.A.) May 11th, 1942. No. 565379.

**CATHODE-RAY TUBES**

A CONDUCTIVE disc of sheet metal, or of colloidal graphite, is laid on the outer surface of the glass bulb, close to the fluorescent screen, and serves to apply radial deflections to the spot when making records against a circular time base. The deflecting voltages can be applied between this outer disc and the internal conductive coating usually found near the top end of the bulb; or the final anode may serve as the second electrode for the purpose. To generate the circular time base, voltages are applied in quadrature across the familiar two pairs of plates.

Although the radial deflections of the spot are not linear over a wide range of voltage, they are sufficiently so to give sensitive and accurate indications of short time intervals or of frequencies comparable with that of the time base. It is claimed that a radial deflection sensitivity of the order of 20/V mm. per volt can be obtained, where V is the voltage of the final anode of the gun relative to the cathode.

A. C. Cossor Ltd., and L. A. Woodbridge. Application date February 26th, 1943. No. 563817.



The new Vortexion 50 watt amplifier is the result of over seven years' development with valves of the 6L6 type. Every part of the circuit has been carefully developed, with the result that 50 watts is obtained after the output transformer at approximately 4% total distortion. Some idea of the efficiency of the output valves can be obtained from the fact that they draw only 60 ma. per pair no load, and 160 ma. full load anode current. Separate rectifiers are employed for anode and screen and a Westinghouse for bias.

The response curve is straight from 200 to 15,000 cycles in the standard model. The low frequency response has been purposely reduced to save damage to the speakers with which it may be used, due to excessive movement of the speech coil.

A tone control is fitted, and the large eight section output transformer is available to match, 15-60-125-250 ohms. These output lines can be matched using all sections of windings, and will deliver the full response to the loud speakers with extremely low overall harmonic distortion.

PRICE (with 807, etc., type valves) \$18.10.0

Plus 25% War Increase

MANY HUNDREDS ALREADY IN USE

Supplied only against Government Contracts

**VORTEXION LTD.**  
257, THE BROADWAY,  
WIMBLEDON, S. W. 19.  
Phone: LiBerly 2814

Are you ready with your post-war pack?



**THOMPSON & NORRIS**  
CORRUGATED  
FIBRE-BOARD PACKINGS



When planning for peace do not forget that the cost of your products will be considerably affected by the packing. Guard against high breakage, freight and storage costs by asking Thompson & Norris to help

you design the best possible pack. While packings for the safe transit of vital war supplies must still have first call, Thompson & Norris can assist with designs and samples. Act in good time and apply now.

THE THOMPSON & NORRIS MANUFACTURING CO. LTD., Great West Rd., Brentford, Middx · Ealing 4555 · Factories also at Hayes, Hilston and Edinburgh

## SENSITIVE INSTRUMENTS

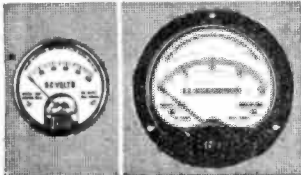

MODEL 200  
2" SCALE

MODEL 350  
3½" SCALE

Specialising in the manufacturing of robustly constructed sensitive Moving Coil and Rectifier Instruments, we are regularly supplying these with sensitivities as low as 20  $\mu$ A full scale in both Moving Coil and Rectifier types.

These Instruments are also available as Thermocouple types as low as 1.25 mA full scale. Spade type or Knife Edge pointers and Mirror scales are available on most instru-

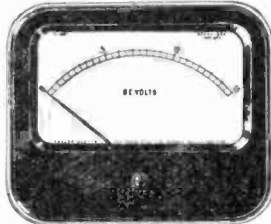

MODEL 500 5" SCALE



MODEL 400 4" SCALE  
ments and illuminated dials can be supplied on Model 400 and 500 instruments.

**IMMEDIATE DELIVERY.**  
For some time past, we have been carrying a small varied stock of most ranges of moving coil instruments. We are able to give immediate delivery for urgent orders

**Taylor**  
electrical instruments Ltd.

TAYLOR ELECTRICAL INSTRUMENTS LTD.,  
419-424 MONTROSE AVENUE, SLOUGH, BUCKS. Phone: Slough 21381



Makers of  
the famous

**DANK**  
SWITCH

The only switch  
with  
FLOATING ROTOR  
& DOUBLE CONTACT

**MILLIONS · IN · USE**

Available in a wide range of circuit combinations for radio, television and other applications.

**BRITISH N.S.F. CO. LTD.**  
KEIGHLEY, YORKS.

\*Phone: KEIGHLEY 4221/4

\*Grams: ENESEF, KEIGHLEY

GA



Made to  
measure

The standard Spire nut is only one form, and the most elementary form at that, of fixing by the Spire method. There are already over 300 special Spire designs, each of which has been "made to measure," for some particular job. In most of them no separate nut or washer is needed. The Spire fixing is part of the component itself. It is pretty safe to say that Spire can simplify *most* assembly jobs. Send us along any ordinary assembly-parts or drawings. We'll see if we can't cut out some of the bits and pieces and reduce the operational time by designing a Spire assembly. No charge for this. If it works we'll get your order. If it doesn't we'll tell you so and there's no harm done.

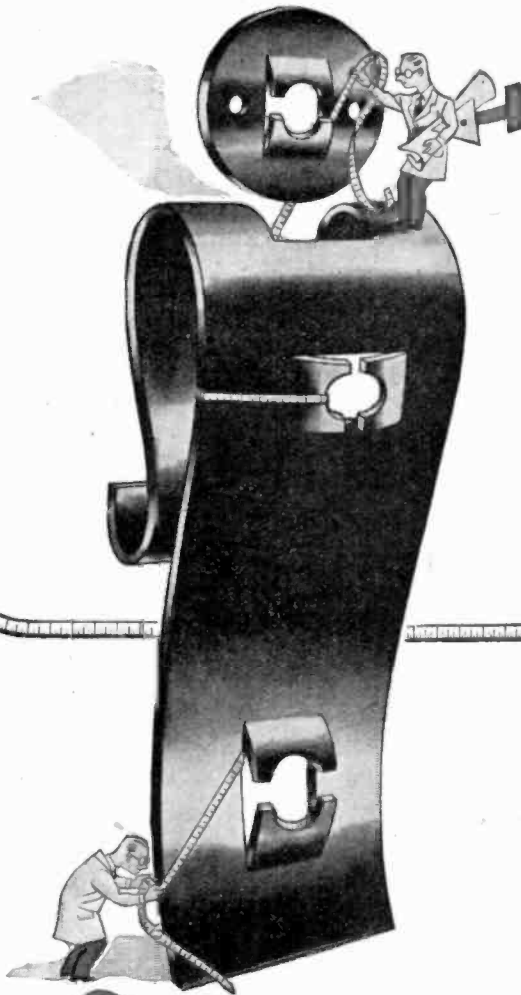

**THAT'S Fixed THAT! NP 1506.**

Aircraft manufacturers and coachwork builders employing stressed skin construction are saving time and money and material by the use of this simple Spire fixing. It serves to hold the tack bolts in position until riveting of skin sections has been completed. It is quicker to use than the usual square pressed nut and is easily removed for further use when its 'holding job' is done.

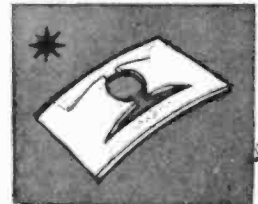

**Spire**

\* **A BETTER way of fixing**

Note 6/- for 3 lines or less and 8/- for every additional line of post charges, average lines 5-6 words. Box Numbers 2 words plus 1/- Press Day: June 1945 issue, first post Wednesday, May 9th. No responsibility accepted for errors.

Under Defence Regulations 1939, Statutory Rules and Orders 1940, Numbr 1689, a permit (199G) must be obtained before sale or purchase of certain electrical and wireless apparatus particularly such valves and apparatus as are applicable to wireless transmission.

### NEW RECEIVERS AND AMPLIFIERS— H.P. RADIO SERVICES, Ltd., offer:—

**CIVILIAN** ac wartime receiver, £12/3/4; battery model, £10/19; 5w ac/dc 3V amplifier with valves, neat chassis construction, £6/10; Celestion, L.S. matched to suit, £1/13; Shatesbury 6v 15w portable amplifying equipment, mike, 2 speakers, etc., £45.

**ROTHERMEL** senior crystal pickup, 78/9; Rola 8in P.M. speaker, £2/-; Celestion 8in with transformer, 25/6; Vitavox 12in 10w, 25/18/6; Universal output transformers, 7/6; Mullard ac Universal measuring bridges, latest type, 15gns; Mullard B100 cathode-ray tube unit with 3in tube, 12gns.; 0-1ma meters, 4 1/2in diameter, £4/10; Osram (T1C gas-filled relays, 25/-; Mullard HVR2A high voltage rectifiers, 20/-.

**PUBLICATIONS**—"Radio Circuits," 2/-; "Radio Manual," 1/-; "Modern Radio Test Gear Construction," 1/6; "Short Wave Handbook," 2/-; "Manual of Disc Recording," 2/-; "Radio Valve Manual," 3/6; "Amplifier Manual," 2/-; "Radio Inside Out," 4/6; "Radio Reference Handbook," 10/6.

**POSTAGE** extra under £4. Send for price list, 1d. plus s.a.e., you'll find it interesting.  
H.P. RADIO SERVICES, Ltd., 55, County Rd., Walton, Liverpool, 4. Tel. Aintree 1445. Estab. 1935. [3732]

**COMMUNICATION** receivers. — Remember "Dale" after the war.—Dale Electronics, Ltd., 152-6, Gt. Portland St., W.1. Mus. 1023.

**H.R.O.** communication receiver, brand new, unopened, latest model; exchange for good talkie projector or other receiver & cash.—Box 120, Parrs, 121, Kingsway, W.C.2. [3720]

**6-VALVE** M.W. superhet. tuning unit, 10-way P.B. control (motor type), A.F.C., amp. A.V.C., Red E valves; best offer over £12.—Edwards, 71, Hill Lane, Southampton.

**QUALITY** amplifiers, 200-250v ac, 5w, 8 1/2gns.; 12w, £14; output impedance to requirements, both types; s.a.e. for leaflet and copy "Design for Quality."—J. H. Brierley (Gramophone Recordings), Ltd., 403, Mill St., Liverpool, 8. [3195]

**4-VALVE** ac/dc Midget kit set, complete with all components, selective, no overlapping, valves, 5in speaker, chassis, 10x4x2 1/2, nothing else to buy, immediate delivery; £8/10.—Henry's, 5, Harrow Road, Edgware Road, London, W.2. [3754]

**BAKER'S**—New 7-valve "Wireless World" Quality amplifier with tone control stage, 8 watts push-pull triode output, price includes super Quality triple cone, 12in permanent magnet speaker, with large output transformer and all valves; also as above but with 15 watts tetrode output, ideal for realistic reproduction for public address; limited orders only; 2/4d. stamp for particulars, prices, etc.—Bakers Selhurst Radio, Tel. Croydon 4226.

**RECEIVERS, AMPLIFIERS—SECOND-HAND SALE**, 8X23, perfect; £60; no speaker.—Minor, Broad Park, Exmouth. [3674]

**HALLICRAFTER** Super Skyrider, 5x16, as new; offers wanted.—Box 3426. [3706]

**HALLICRAFTERS** 8X17, speaker, 1851, first R.F.; marvellous; offers.—Box 3410.

**N**o. 2 Monodial, with amplifier; £25.—Goldthorpe, 46, Meadow St., Rotherham. [3659]

**R**.G.D. 6-valve set, 4 bands, condition as new; £24.—BM/ECHT, London, W.C.1.

**HALLICRAFTER'S** dual diversity 25-valve receiver; offers or exchange.—Box 3434.

**COMMUNICATION** receivers, new 8X24, speaker and spare set valves, also Trophy Six.—Offers to Box 3423. [3692]

**15**w. a.c. amplifier, £10; or exchange for autochange gram. motor.—Royston, Bodiam, St. Fillans Rd., S.E.6. [3655]

**MURPHY** A82 short-wave receiver, little used, and perfect condition; £25.—Box 3406; or 'phone Bays, 4722. [3682]

**SOUND** Sales 12-watt amplifier (2-PX25), with tuner unit and Magnavox 66, as new; £40, or offer; S.E. London.—Box 3411.

**SALE**, 1939 18-valve Challenger super twin chassis, 6-wave, 4 1/2-2,000, fitted in metal cabinet, with separate G.12 p.m. speaker.—25, Yarrow Place, Bolton. [3769]

**SOUND** sales, 83346 amplifier, also speakers; sound sales, 11in p.m.; Pamphonic 18in energised with ac pack; R.K. Senior, energised.—Reasonable offers to Bress, 22, Highfield Ave., Pinner, Middx. Tel. 1568. [3766]

### POST-WAR PLANNING

Why not let us handle your transformer problems?

If transformers are employed in the equipment you manufacture, we shall be glad to give you the advantage of our experience and to offer the same efficient service that has won the confidence of the Government Experimental Establishments and of the Leading Industrial Organisations.

The solution of individual problems has for many years formed a part of our normal day's work. The production in quantity of **PARTRIDGE TRANSFORMERS** has been built upon the unique knowledge thus accumulated.

Telephone:



ADCOY 2244

## PARTRIDGE TRANSFORMERS LTD

76-8, PETTY FRANCE, LONDON, S.W.1

## SOLON INDUSTRIAL ELECTRIC APPLIANCES

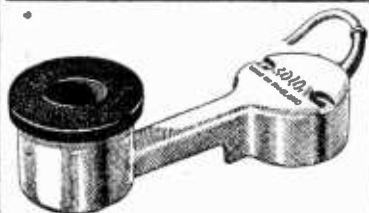

SOLON ELECTRIC SOLDER POT

The **SOLON** Electric Solder Pot maintains 1/2 lb. solder at working temperature. Full details are given in Folder Y.9, which also describes the range of **SOLON** Electric Soldering Irons and the **SOLON** Electric Insulation Stripper. Please write for details of **SOLON** INDUSTRIAL ELECTRIC APPLIANCES.

**W. T. HENLEY'S TELEGRAPH WORKS CO., LTD.,**  
WESTCOTT, DORKING, SURREY.

**OFFERS?** Q.A. Super, slightly modified, spare valves; Westinghouse h.t.16, with Sound Sales mains trans. for above; Parmeko O.P. trans, 28:1; vendor now on d.c.—Box 3405.

**MONODIAL** superhet, complete with valves and Hartley Turner loudspeaker in baffle, assembled but not ganged, £37; Parmeko type No. 4 mains transformer £4/5, and 2 Mazda U65/550 rectifiers, unused, 37/—Box 3428.

**FOR** sale, Pye Paraphonic R.G.D. 11 valve all wave auto-change radiogram, in solid oak cabinet, loudspeaker in separate ditty, condition as new; price 126gns.—Sleeches Farm, High Hurstwood, Uckfield. Tel. Buxted 264.

**EDDYSTONE** E.C.R. 10-v. communication rec., 1.6-32 m/c crystal gage, built-in b/cast adaptor, crystal oscillator & multivibrator & decibel meter; metal valves; Hallicrafter speaker; perf. cond.; best offer over £65.—16, Bourne End Rd., Northwood, Middx. Nthwd. 230.

**NATIONAL** H.R.O. receiver, complete with mains, and nine sets of coils, believed 1939 model, listed in U.S.A. catalogue at over 600 dollars; condition perfect and untouched by service engineers; best offer over £90.—Champion, 43, Uplands Way, N.21. Tel. Lab. 4457.

**HARTLEY-TURNER** speaker and amplifier, 10in separately energised 2,000 ohm speaker in box-baffle cabinet, amplifier with 4-volt amplifying and rectifying valves, 2 K166 output valves with feedback, remote volume and tone controls, superbly made and in perfect condition; £35 complete.—Potter, Fieldways, West End, Chobham, Surrey. [3685]

**H.M.V.** amplifying equipment, comprising double turntable playing desk in console cabinet with 120 watt 12 DA60s in push pull, double rack amplifier in base, 2 12in speakers in cabinets, provision for radio and microphone inputs, separate microphone amplifier in metal case, E.M.I. moving coil microphone, in perfect working order; cost £310, accept £145.—Harris, Strouds, Bradford, Berks. [3759]

**NEW LOUDSPEAKERS**  
NEW Broadcast P.M. loud-speakers, 3 models; 12in 12watt 15,500 lines, 1 3/4 dia, voice coil; 12in 25watt 18,000 lines, 1 3/4 dia, voice coil; 15in 40watt 18,000 lines, 2 1/4 dia, voice coil; machined and precision built instruments, Ticonal magnets, detachable diaphragm, die-cast chassis, uniform response, accuracy, tonal quality, appearance and finish; superior standards in fidelity, sensitivity, prompt deliveries; specifications and illus. upon request.—Broadcast & Acoustic Eq. Co., Ltd., Broadcast House, Tombland, Norwich. [2537]

£5 Auditorium permanent magnet speaker with triple cone, manufactured by Bakers Selhurst Radio, the pioneer manufacturers of moving coil speakers since 1925, wide frequency range, even response, ideal for quality reproduction, fitted with magnet, having exceptionally high flux density in the air gap, suitable for public address equipment when quality reproduction is first consideration; send 2/4d. stamp for leaflet giving details of above and constructional details of a new acoustic chamber designed to extend loud speaker frequency range; also constructional details of an infinite baffle cabinet; every music lover interested in realistic reproduction should write for leaflet.

£8/19/6.—New Baker super power cinema permanent magnet speaker with 18in triple cone of new design, giving wide frequency response free from objectionable resonances; speech is clear and natural and music is reproduced with exceptional realism; fine engineering job, extremely sensitive, ideal for public address equipment when power handling capacity, plus realistic reproduction, is required; present deliveries of speakers three to four weeks.—Bakers Selhurst Radio, 75, Sussex Rd., S. Croydon. Tel. Croydon 6813.

**LOUDSPEAKERS, SECOND-HAND**  
BAKER'S Selhurst loudspeaker, mains energised with rectifiers, high impedance speech coil; bargain; Molesey 1271. [3694]

**F**EW only, 2 1/2in p.m. speakers, 27/-, c.o.d. or c.w.; 2ma meters with 300 & 600 ohm, £3.—Hayes Radio, 18, Holloway Arcade, N.7.

**MAGNAVOX** moving coil speaker in case, Marconi eliminator, 230 volts.—Scammells, Fashion St., E.1, Bishopsgate 3521.

**VOIGT** p.a. horn without unit, built into oak table for home use, tilting device, excellent finish; offers.—Andrews, 8, Grove Park Terrace, London, W.4. [3729]

**T**WO B.T.H. 11in R.K.s on baffle 150hm speech coils, rectifier, 200-240 v.a.c., £11; exchange signal generator or testing set.—22, Friars Place, Lano, W.3. [3713]

**DYNAMOS, MOTORS, ETC.**  
**CONVERTER**, 1100-2500c, 90v, perfect; £5.—Byrne, 59, Wood Vale, N.10. [3695]

**E.C.** converter, 100v dc input, 230v, 0.521a, ac output, excellent condition; offers.—8, Sebright Ave., Worcester. [3742]

# PREMIER RADIO

ALL POST ORDERS TO:

JUBILEE WORKS, 167, LOWER CLAPTON ROAD, LONDON, E.5. (Amherst 4723.)

CALLERS TO:

JUBILEE WORKS or

109, FLEET STREET, E.C.4. (Central 2440.)

Send for details of other accessories available.

All enquiries must be accompanied by a 2½d. stamp.

**METERS.** First grade army type Universal Test Meters in shockproof bakelite cases, ranges 10, 100, 500 volts, at 1,000 ohms per volt A/C and D/C, 1, 10, 100 mA D/C, 0-50,000 ohms. \$8 15s. 0d.

**FIRST GRADE METERS.** ¾in. diameter 1 milliamper, \$2 12s.; 500 microamps, \$2 18s. 6d. 4½in. 1 milliamper, \$3 6s. 0d.; 500 microamps \$3 11s. 6d. Westinghouse Meter Rectifier for either type, 10/-; built-in ohms per volt A/C and D/C, 10/- Any value multiplier, 2/6 each.

**SUPER QUALITY AMPLIFIERS.** 12 watts output, high and low gain inputs with mixer, treble and bass controls, two DB 30-11,000 cycles, negative feedback, 2, 4, 8 and 15 ohms output, 21d 14s.

**AC/DC AMPLIFIERS.** 5 watts output, high gain, three-stage, feedback, \$8 8s. 0d.

**BATTERY CHARGERS** for 2 v. batt. at 1 a., 25/-; for 2, 4 or 6 v. batt. at 1 a., 45/-; for 6 v. batt. at 1 a., 30/-; for 2, 4 or 6 v. batt. at 1 a., 48/-; for 6 v. batt. at 1 a., \$3 10s.

**MAINS TRANSFORMERS.** 300 + 300 v., 60 m/a, three 4 v. 2-3 a. windings, 25/-; 350 + 350 100 m/a, 5 v. 2 a., 6.3 v. 2-3 a., 29/-; 350 + 350 100 m/a, three 4 v. 2-3 a. windings, 29/-; 350 + 350 100 m/a, two 4 v. 2-3 a., two 4 v. 1 a. windings, 39/-; 350 + 350 150 m/a, 5 v. 2 a., 6.3 v. 2 a., 6.3 v. 2 a., 38/-; 500 + 500 250 m/a, 5 v. 2 a., 6.3 v. 2 a., 6.3 v. 2 a., 65/-; 425 + 425 200 m/a, 4 v. 2-3 a., 4 v. 2-3 a., 4 v. 3-6 a., 47/-; 250 + 250 150 m/a, 4 v. 1-2 a., 4 v. 2-3 a., 4 v. 3-4 a., 36/-; 500 + 500 150 m/a, four 4 v. 2-3 a. L-T windings, 47/-.

**12-VOLT BATTERY S.W. RECEIVER,** with 2-volt valve, 4 coils, 12-170 m. bandspread tuning, 55/-, including tax.

**STEEL CHASSIS,** 10x8x2½", 7/-; 16x8", 8/6; 20x8", 10/6.

**SHORT-WAVE COILS,** fit octal sockets, 4-pin aerial coils, 9-15, 12-26, 22-47, 41-94, or 76-170 m., 2/6 each; 150-250 or 250-500 m., 3/-; 400-1000 or 1000-2000 m., 4/-; 6-pin H.F. Trans., 9-16, 12-26, 22-47, 41-94, or 76-170 m., 2/6. S.W. chokes, 10-100 m., 1/3; 5-200 m., 2/6.

**SHORT-WAVE CONDENSERS,** all brass, easily ganged, 16 mmfd., 2/11, 25 mmfd. 3/3, 40 mmfd. 3/8, 100 mmfd. 3/11, 150 mmfd. 4/8, 250 mmfd. 5/8, 2-gang 160 mmfd. 15/-; shaft couplers, 7d.; flexible ditto, 1/6.

**MIDGET 2 TUBE COILS,** 12-35, 16-47, 34-100, 91-261, 250-750, 700-2000, 300-570, available as H.F. trans., aerial, or osc. coils, 2/5 each. Suitable Yaxley type wave-change switches, every type available; locators, 2/- each; wafers, 1/- each. Suitable small 2-gang condensers - .0005, 15/-; suitable matched pairs iron-cored 465 W.C. 1.0 H. trans., 1/6 each; midget type, 21/- pair.

**PUSH BUTTON TUNING PACKS.** 16-47, 200/550, 1000/2000 metres, completely wired, adjustable iron cores, aerial and osc. coils, with superhet circuit, 30/-.

**CONDENSERS.** 1 mf. 450 v., 7/8; 2 mf. 300 v., 3/9; 50 mf. 30 v., 3/-; 16 mf. 150 v., 7/8; 50 mf. 12 v., 2/3; 500 mf. 12 v., 12/6. Repairer's kit, 20/- assortment resistors and condensers, three 8 mf. 450 v. electrolytics, six octal sockets, 12 yds. pushback, 35/- the lot.

**CRYSTAL PICKUPS.** Cosmocond, \$2 11s. 0d. Rothermel super, \$3 18s. 9d.

**AMERICAN 2 VALVES,** 45Z3, 35Z5, 25Z5, 12SK7, 12SJ7, 25Z6, 12V6, 6F8, 5Z4, 80, 6L7, 6K7. Many others available.

**SUPER GIANT PUSH-PULL INTER-VALVE TRANSFORMERS,** 21/-; midget type, 12/6.

**MIDGET ALL-WAVE RADIOS,** AC/DC. We can supply circuit and all parts for sale. Write for details.

**MOVING COIL SPEAKERS.** Rola 6j- or 8-inch P.M., no trans., 25/-; Plessey 8-inch P.M. with trans., 29/6. Goodman 3½-inch P.M. with 3 or 15 ohm voice coil, no trans., 30/-; 8-inch 1200 ohm energised speakers, 35/-; Midget, standard or P.P. trans. for an above, 10/6. Super quality giant Matchmaker output transformers, match any tube single or P.P. to any voice coil, 7-watt, 22/6; 15-watt, 30/-; 30-watt, 49/6; 60-watt, 59/6.

**CHOKES.** 8H, 300 ohms, 40 m/a, 4/6; 30H, 400 ohms, 60 m/a, 13/-; 30H, 100 m/a, 400 ohms, 19/6; 30H, 185 ohms, 150 m/a, 25/-; 25H, 220 m/a, 120 ohms, 39/6.

**SUNDRIES.** 2 mm. Systoflex, 2½d. yd.; Tinned-cored solder, 6d. per coil or 4/6 per lb.; screened 2-pin plugs and socket, 9d.; ditto, 8-pin, 2/-. Octal sockets, 10d.; 4, 5, 6, 8 pin, 2/6. Valve screws, 1/2; 8 v. vibrator, 4-pin, 12/6. 50ft. Indoor Aerial, 2/6.

**OSCILLOSCOPES,** signal generators, multi range test meters, etc., test gear of every description, British or American, repaired, serviced, recalibrated.—A. Huckelbees, "Hazelside," Coton Lane, Orpington, Kent. [3031]

**FURZEHILL LABORATORIES,** beat frequency oscillator, type AF2; Cossor impedance bridge, model 3589; offers.—5, Upper Brook St., Rugeley, Staffs. [3718]

**E.M.I. oscillator,** MW, LW and IF covered, needs batteries, £5; Weston set analyser, in case, perfect, some accessories, £11.—Lyon, Churchgate St., Soham, Cambs. [3717]

**WESTON E665 analyser,** as new condition, complete with English circuit selector, a few octal adaptors, jumper pins and test leads, in black carrying case with keys, £20; Eta hand coil winder, in first-class condition, £18; Hallcrafters, 13-valve super skydriver, in immaculate condition, all-metal valves with B.F.O. crystal gate, bandspread, noise suppressor and every desirable feature for a super performance over 5 wavebands, complete with large matched speaker and makers' technical manual, £80; details of all the above on request.—Box 3435. [3753]

**GRAMOPHONE AND SOUND EQUIPMENT**

**H.M.V. hypersensitive pick-up** with trans. and matching unit.—Box 3427. [3707]

**NEEDLE armature pick-ups,** to Hay's spec.; order: £7.—Goldthorpe, 46, Meadow St., Rotham, Notts. [3660]

**GRAM.** unit, comprising Garrard a.c. motor and Rothermel Senior P.U., mounted in case; £12.—Jacoby, 37, Hill St., W.1. [3668]

**V.G. tracker and motor,** 80 "K" cutters, 1,000 trailers, 16 double-sided 12in discs, perfect; would separate; offers.—Box 3421.

**RECORDING engineer** offers consulting service for disc, film, tape, etc.; advice, diagrams, general information all aspects sound recording; stamp with enquiries.—BM/DISC, London, W.C.1. [3408]

**GARRARD U/10 Universal a.c./d.c. gram. motor,** £4/10; Vitavox K.12/10, 12in P.M. speaker, as new, £5/15. Wanted, Voigt m.c. pick-up transformer for H.M.V. Hyper-sen. pick-up.—Box 3408. [3666]

**GARRARD 100-250 volt a.c. electric 12in gramophone motor and pick-up** on oxidised copper unit plate, as new, £10; Marconi Senior pick-up, oxidised copper finish, £3/10.—90, Balcombe Av., Worthing. [3699]

**RECORDING discs** suitable for all types of machine; in stock; Styli and recording accessories in stock; enquiries invited.—Write to Simon Sound Service (Evacuation address), The Cottage, Greywell Ct., Virginia Water, Ss. [3421]

**VALVES**

**LOOK out for valves and circuit analyser;** details later.—London Sound Labs., Ltd., 40, South Molton Lane, Bond St., London, W.1.

**ALL B.V.A. valves available,** also number of all discontinued types; list prices; pro forma or c.o.d.—David Robinson, Ltd., 100, High St., Bedford. [3421]

**COMPONENTS—SECOND-HAND, SURPLUS VALUE!** Matt has it!

**LINE CORD.**—2 way 2/6 per yd, 3-way 3/- per yd (approx 60 ohms per foot)

**SPEAKERS.**—Celestion P.M. 2½in, less trans, 27/-; 8in P.M. with trans, 27/6; 6½in P.M. (multi-range trans), 28/6; Rola 6½in P.M. with trans, 28/6.

**TWO gang condensers,** 0.00005 with trimmers, 12/6; Midget coils h.f. and aerial, 5/- per pair.

**VOLUME controls** (all values), 1-switch 3/6, w/switch 4/6, mains transformers 4v and 6v, 27/6; Rothermel (crystal) pick-ups, metal, 8s, £3/13/6; Senior de luxe, £3/18/9; condensers, all types in stock, 2's, 8's, 16's, 20/20, 500v working; 0.1, 0.01, 0.25 0.05, 25x225, etc. Resistances, ½ and 1 watt; all values 1/- each, 10/6 per doz.

**LET us quote you for all your requirements.** Cash with order, plus postage.

**MATT RADIO SERVICE,** 152, Richmond Rd., Kingston-on-Thames, Surrey. [3758]

**TRANSFORMERS,** built to performance specifications. Phillips, 1, Lister Gdns., N.18.

**5 GROSS yds. 1.5mm Systoflex,** 50 gross 6 B.A. nuts and screws; offers.—Box 3438.

**SPEAKERS,** all p.m., 4in 22/6, 3½in 22/6, 6in, 22/6, 8in, 22/6, Rola, Goodman, Plessey and Celestion, all less trans.

**SPEAKER trans.,** 3w pen 7/6, midget pen 6/-, centre tapped 6/6.

**CHOKES,** 15h 60ma 7/6, 100ma 12/6.

**CRYSTAL mikes,** first class brush crystal with screened flex, £3/3.

**SOLDERING** irons, 60w 230v. light, 14/6.—See other ads. in this issue or send ld. for list to Radionics, BCM/Sales, London, W.C.1.

**RX-MANUFACTURER'S stock.** Condensers, eliminators, etc.; a.s.c. for list.—Wood 28, South Park Drive, Blackpool. [3738]

**PARMEKO** o.p. tran, pair Px25 to 2, 15s. 32ohms, 30/-; quality mains trans, 500v 150mA, 5v 3a, 6.3v 3a, 2x4v 4a, 45/-; B5, 25/-.—232, E. Park Rd., Leicester. [3714]

**H. HARRIS, Strouds, Bradfield.**—Clearance items at bargain prices, all goods in stock, guaranteed in working order and offered subject to being unsold.

**ROTARY converters,** (Crypto 70w 110v ac to 70v dc, £2/10; M.L., 100v dc to 600v 100mA dc, £3; Phyme, 500 watts 110v dc to 70v ac, £5; Janette, 500w 110v dc to 110v ac, £12; Lang, 900w 240v dc to 230v ac, £17; Crypto, 1,500w 75v dc to 230v ac, £17.

**METERS.**—Large stocks of ac and dc switch-board type voltmeters and ampereters, from 15/- each, ranges 0-6 to 0-600 volts, 0.1 to 0-2,000 amps; lists available; stamp please.

**BATTERY chargers.**—Westinghouse type, 200-250v ac to 25v 1¼a dc, in metal case, £4; large Westinghouse type, set 36inx21inx12in, with voltmeter, ampmeter, choke, resistance fuses, etc.; 200-250v ac to 36v ¼a dc, £12/10; Crypto rotary, 230v ac to 36v 4a dc, £7/10; B.K.B. rotary, 230v ac to 50v 6a dc, £7; Neco, 205v ac to 16v 24a dc, £12/10; Phillips valve, 100v ac to 12v 1¼a dc, £2.

**THE above is only a selection of stock held; enquiries solicited.**—H. Harris, Strouds, [3760] field, Berks.

**NEW ac motors,** ¼hp, high starting torque, 200-250v, £4/15; ½hp, £5/5; ¾hp £7/5; 1hp, £9/7/6; all other sizes available; also machinery.—John W. Steel, Bingley, Yorks.

**ELECTRADIX** dynamos and motors at bargain prices, dynamos, ht and Lt G.E.C. double current, 6v and 600v, weight 17lb, 37/6, pkg. and carr. paid; supplied Eng. and Wales only; refund 5/- on returned cases; dc motors, 5-5h hp, 1,500 revs dc motors, enclosed, silent, 220 to 250v, 1,500 revs, double-end ¼in shaft, first grade make, guaranteed, 1-5hp, £3/10 each; ¼hp £4 each; all carr. paid Eng. and Wales; others in stock.—Electradix, 214, Queenstown Rd., Battersea, London.

**ALL types of rotary converters,** electric motors, battery chargers, petrol-electric generator sets, etc., in stock, new and second-hand; supplied against priority orders only.—WARD, 37, White Post Lane, Hackney Wick, E.9. Tel. Amherst, 1395. [1988]

**SPECIAL offer to clear.**—Loudspeaker cabinets, polished oak, 12/6 and 15/6, polished walnut, 17/6 each, delivered in any quantity; any type of radio cabinet made to order; send us your enquiries.—Waldenberg Bros., Ltd., New York Rd., Leeds, 2. [3030]

**NEW MAINS EQUIPMENT**

**LAMINATIONS** for mains transformers available from stock; send 3d. for sample & price.—V. E. S., Radio House, Ruislip, Mdx.

**VORTEXION** mains transformers, chokes, etc., are applied to: G.P.O., B.B.C., L.P.T.B.; why not you? Imitated but equalled; orders can only be accepted against Government contracts.

**VORTEXION, Ltd.,** 257, The Broadway, Wimbledon, London, S.W.19. Lib. 281.

**MAINS transformers,** shrouded 200-250 primaries, type A, 350-0-350, 100ma 4v 6v and 4v 5amp, 25/-; type B as A but 5v and 5v heaters, 25/-; type C as A but 200ma secondary, 42/6; type D as C but 6v and 5v heaters, 42/6; type E as C but 500v secondary, 42/6; type F as E but 6v and 5v heaters, 42/6; push-pull output transformers for amplifiers, 15 watt, 35/-; 25 watt, 35/-; 200ma smoothing chokes, 17/6; many other lines available; send 1d. stamp for complete list.—V. E. S., Radio House, Ruislip, Mdx.

**TEST EQUIPMENT**

**CAMBRIDGE** 0.5 thermionic voltmeter; £10.—52, Standishgate, Wigan. [3746]

**AVOMETER,** 40, perf., in leather shoulder-strap case, £20.—Box 3432. [3735]

**MODEL 40 Avometer,** slightly faulty, in leather case; £15.—Box 3418. [3687]

**UNI. Avo 40,** perf. wkg. cond.; offers.—53, Waterloo Rd., Leyton, E.10. [3762]

**C. Avomizer,** case, perf. cond.; also ditto, needs recalibrating; offers.—Box 3420.

**TAYLOR 81a** and 313a adaptor, perfect; £25, offers.—Wells, 34, Colne Rd., N.21.

**AVO mod. 40,** lesa. case, £19/10; Uni. Minor, £8 5s; both as new; also quantity electrolytics.—Box 3439. [3768]

**EVERSHED** and Vignoles ohmmeter, test leads & prods, in lesa. carrier case; offers.—Grindle, Hillcrest, Douglas Rd., Laindon, Ex.

**TRIPLETT** test meter (666H), brand new; £13. Wanted, Taylormeter.—A. Marks, 102, Cromwell Rd., Peterborough, Northants.

**RADIO Lab.** valve and set tester, good working order, complete with instruction book; offers.—12, High St., Newport, Pagnell.

**AVO 40,** alms. new; Avo. dc. Minor, needs attention, 18 valves; £25 the lot, 18, Shakespeare Av., N.11, nr. Arnos Grove Stn.

**SIGNAL** tracers, ideal for tracking down distortion, etc., £25; 0.1ma meters, round type, first grade, £2/18/10; test prods, 1/9 per pair, available from stock; orders also accepted for Multi-range meters, Avos, Taylors, etc., and for trimming tools; further details by request.—V. E. S., Radio House, Ruislip, Mdx.

# 8 + 8 MFD

Condensers are components mostly required nowadays. Sometimes we have a small supply which is distributed at the official price. At present we are offering well-known makers' products 100% guaranteed by us.

- VALVE HOLDERS.** All bases in stock. 1/-. **DIALS.**—Medium and long-wave stations printed. 1/-. **TWO-GANG CONDENSERS.**—Special midget condenser with trimmers. 15/6. **THREE-GANG CONDENSERS.**—Standard type. 12/6. **MAINS TRANSFORMERS.**—RME 200/230 volts 300-0-300, 4v. 4 amps., 4v. 2 amps. 37/6. **ACCUMULATORS.**—Multi-plate, 2v., 17/6. **SPEAKER TRANSFORMERS.**—Universal output (Pentode and Power). 6/8. Universal Midget model. 6/8. **VOLUME CONTROLS.**—Most values in stock, with switch. 6/8, less switch, 4/8. **POTENTIOMETER.**—Wire wound, variable, 0-10 ohms, complete with knob. 3/8. **TRIMMER SCREWDRIVERS.**—Non-capacity ebonite. 1/8 each. **RESISTORS.**—1-watt, card of 36 assorted values. 27/6; 1-watt, 28/-; 5 and 10 watts, 12 values assorted. 21/-. **DROPPERS.**—Ready to fit, 1/2 doz. assorted: Cosmor, Ferranti, Decca, Maestro, Ferguson, Ekco, instead of 22/34. 37/6. **VARIABLE MAJNS DROPPER RESISTORS.**—2 or 3 amps. 6/8. Resistors in cages to permit fixing outside set. .3 amps., 740 ohms. 11/8. **TRF COILS.**—Set of medium wave coils (Aerial and HF), complete with diagram. 9/6. **LINE CORD.**—2 core 3, 3/11 per yd.; 3 core 3, 4/8 per yd. (60 ohms per foot). **SPEAKERS.**—8in. Roia, less transformer. 23/-. **VIBRATORS.**—Brand new American "MALLORY," 6v. 4-pin, fully guaranteed. 13/6.

**MODERN AIDS**

- "TESTOSCOPE," the vest pocket instrument for tracing faults. Enables 30 tests AC/DC, complete with leads. 37/8.
- "ELCO" Electrical Light-Weight Soldering Iron (state voltage). 13/6. "FLIX-O-DISK," a novel calculator of Ohm's Law problems 6/8.
- MOVING COIL METERS,** 30 amps., charge, discharge bakelite base. 10/6.
- CAR AERIALS,** telescopic, nickel-plated. 21/-.

**RADIO LITERATURE**

- Equivalent Charts, our unique booklet, including BULLETIN. 1/7.
- Handbook on American Midget Sets. 2/7.
- Manual of British and American Valves, with characteristics and data. 3/6.
- Radio Simplified. 4/8.
- Basic Radio. 5/3.
- Introducing Radio Servicing. 6/8.
- Various Service Sheets. 10/6 per doz.
- Valves, see advertisement April issue.
- Orders under 10/- C.W.O., otherwise C.O.D. Stamp with enquiries, please. B.O.T. retail prices.

## J. BULL & SONS

(Dept. W.W.),  
246, HIGH STREET,  
HARLESDEN, N.W.10

### PHOTO-ELECTRIC CELLS

Se/Te on gold-alloy, super-sensitive to light, gas-filled, permanent, operate relay direct or with Valve Amplifier, perfect reproduction of Speech and Music from sound track of films; large tube 3 1/2 in. from glass top to valve pin base, 1 in. diam., 38/-; medium, 2 1/2 in. long, 35/-; small tube 2 in. from top to terminal base, 3/4 in. diam., 30/-; miniature cell, glass top to cap base, 1 in. overall, 3/4 in. diam., thin flex leads, 28/-; all cells operate on 40-100 volts. Connections diagrams free.

**PRECISION OPTICAL SYSTEM,** producing fine line of light from any car headlight bulb, for scanning film sound track direct into Photo-cell, metal tube 2 in. long, 3/4 in. diam., 3/4 in. focus, 52/-. Instructions free. Goods by return.

**GEFA INSTRUMENTS,** 38a, York Street, TWICKENHAM, Middx. POPesgrove 6597

G. A. RYALL, 36, Huron Road, London, S.W.17.—Mail order only; no c.o.d. under £1 please.

**TEN-WAY** cable, good conductors, 1/3 yard, 3 yards 2/9; push-back connecting wire, stranded, 2 colours, cotton covered, 12 yards 2/3; twin rubber, flexible, one cover, for mains, leads, etc., 3 yards 2/9. **MORGANITE** long-spindle volume controls, 10,000 ohms, less switch, 3/- each; Centralab 1, meg. vols., less switch, 5/9; dial plates, oblong, 5 1/2 x 2 1/2. Varley 200-550, etc., transparent, 4 1/6; Burndept 4-band dial, 8 x 5 1/2, s.w. on lower half of scale, 1/6 each. **MICROPHONE** capsules by Standard Telephones, 3/- each; h.f. chokes on ebonite bobbins, 5,000 ohms 1/3 each. **SPECIAL** offer T.C.C. mica condensers, double 0.0001 x 0.0001, five (ten condensers) for 1/3; Hunts 0.01 mica, 1/- each; Yaxley type low-loss switches, single pole, double throw, 2-bank, 2/9; single bank, 2/3. **YAXLEY** type switches, 3-bank, 2-pole, 4-way, with middle screen, long spindle, 4 shorting bars, 6/9 each. **ERIE** colour-coded resistances, 2-watt, 860, 6,800, 140,000, 150,000, 220,000, 470,000, 820,000, 2 1/3; Erie 3w, 680 ohms, 1/3 ea. **INPUT** strips, 2 in x 3/4 in, with terminal screws, 2-way, 2/6 dozen; anchor or mounting strips, 5-way, spaced for half and one watt resistances, 2/6 dozen.

**VALVE-HOLDERS,** chassis type, our regular line in these available once again, 5- and 7-pin British, 5- and 6-pin UK American, International Octal (for 6V6, etc.), all 4/6 per dozen, or per 100 29/6.

**TELE-RADIO (1943), Ltd.,** for brand new T good quality components at manufacturers' list prices.

**SUPPLIERS** to British & Allied Services & Government departments, professional constructors and amateurs who want only the best. **WESTON** meters, 0-1mA, 22/10; 0-500 micro amps, 23; 0-100 micro amps, 23/15; 0-50 micro amps, 24/10; 1mA instrument rectifiers, 12/6. "Spot-on" wire-wound precision resistors, plus or minus 0.05%, 5/6 each (up to 50,000 ohms only); single-pole 12-position switches, 3/6 each; 4-pole 3-way, 3/6 each; cathode ray tubes, G.E.C. 1 1/2 in, 22/15; Cosor 25D, 2 1/4 in, 23/6 Cosor 26D, 4 1/2 in, 26/10; Cosor GDT4B gas-filled triode, 24/4; high-voltage rectifiers and condensers; potentiometers, carbon, 4/6, with switch 6/6, wire-wound 6/6, all usual values; crystals, 100kc, 45/- (P.O. perm.); Rothermel crystal pickups, 23/13/6 and 23/18/9 (high fidelity Red Label 10/- extra); Celestion, Goodman and Vitavox speakers. Postal enquiries acknowledged same day, cash or c.o.d. orders, if in stock, 24 hours' service; postage and packing extra on all goods.

**TELE-RADIO (1943), Ltd.,** 177a, Edgware Rd., London, W.2 (corner of Edgware Rd. and Sussex Gardens). Tel. Pad. 6116. Grams. "Goahead," Padd, London.

**LOOK** out for valves and circuit analyser; details later.—London Bound Labs., Ltd., 40, South Molton Lane, Bond St., London, W.1.

**PRICE** list 1d., unequalled range; example value: Yaxley 4-bank 6-way switches, 5/6.—Taylor, Macaulay St., Huddersfield.

**RESISTORS,** 1/4 4d., 1/8 6d., 1 watt 9d.; condensers, 0.0001 to 0.005 9d., 0.01 to 0.05 1/-, 0.25 1/6, 0.5 2/6, 0.1 9d.; bias elec., 25/25s 2/6, 50/12s 2/6, 10md/50v 2/6.

**VALVE** holders, 4- and 5-pin 6d., 7- and 9-pin 9d., Max. and Int. octal 9d., all American; No. UK at 9d. each.

**VOLUME** controls, most values, with and without s.w., 5/6 and 4/6.

**MANY** other lines, 1d. for list.—Radiosales BCM/SALES, London, W.C.1. (3725)

**NOW** available, S.P.K.R., fret. fabric, 6d. ft.; 2 gangs, 10/6; T.R.F. coils, 2/3; P.M.s, 6 1/4 in or 8 in, 19/6; rubber feet, 1 1/2 d.; bushes, 1d.; electrolytics, etc.; list 2d.; mail order only.—16, St. Helena Ave., L. Incom.

**PHILIPS** Quality corrector, type 4505, gives bass and treble control, ideal P.A. or gram. amplifier, 24/10; dynameter valve-tester, tests all usual types, 26/6; Baker 12in P.M. speaker chassis, 15 ohm coil, handle 5 watts, 22/12/6.—52, Standishgate, Wigan.

**SERVOEMEN.** The following products are well designed and of high quality; volume controls, carbon type, all values, with or less switch, wire-wound resistors, 1 to 60 watts; dropper resistors, 0.2 and 0.5 amp; line cords and razor resistors; terms and quotations on req.—Dagole, Ltd., 55, High St., Ruslip, Mdx.

**LINE** cord, the finest quality obtainable, with heavy asbestos insulation, 80-70 ohms per foot, 2-way 1/2, 3-way 1/3 per foot; p.m. speakers, with transformers, 6 1/2 in 30/-, 8 in 32/6, 10 in 45/-; Morse tappers and buzzers, 5/- retail line, 3/8 each; B.V.A. valves at list price; cables and packing extra, c.o.d. or a.w.o.—Park Radio Service, 27, Upper St., London, N.1. (5819)

## RADIO INSTRUMENT CO.



Radio Products  
294, BROADWAY,  
BEXLEYHEATH, KENT



### THE BROADWAY T.R.F. RECEIVER KIT (A.C. Mains)

With all components, ready-to-assemble cabinet, silvered dial, P.M. Speaker. Valves: KT61, 6J7, 6F6, 6Z4. Complete kit ... £11 11 0

**THE BROADWAY AUDIO AMPLIFIER, A35.** Paraphase transformer, coupled 6L6's with neg. feedback. Two input mixer stage, tone and volume control. Multi-ratio output transformer. Paper smoothing condensers. Valves: 6J7, 6J7, 6J5 6L6, 6L6, 6U4. Complete kit ... £25 0 0

**THE BROADWAY AUDIO AMPLIFIER, A15.** Paraphase R.C. coupled 6F6's, with tapped OP transformer. 3/5/8/15 ohm line. With tone and volume control. Ideal as gram. reproducer and mike amplifier. Complete kit ... £12 10

Full size prints of each above kit, 2/6 each.

**FACTORS AND DEALERS SPECIAL DISCOUNTS.** Some new lines, including eliminators, being released. Write us for details.

## THE RADIO INSTRUMENT CO., BROADWAY, BEXLEYHEATH.

*just because they give no trouble— don't forget*

# DALY ELECTROLYTICS

—they're serving you well!

## DALY (CONDENSERS) LTD

Condenser Specialists for over 20 years  
West Lodge Works, The Green, Basing, W5  
Telephone: Basing 4841

**DUAL TESTOSCOPE**

This new dual model indicates 2 to 30 volts and 100—750 volts.  
Good allowance for your old charge  
Send for interesting leaflet (R.14) on "Testose."

**RUNBAKEN-MANCHESTER-1**



## Ready for Peace time ?

When you get "on the air" again, will you be able to read the speedy, well spaced messages sent by your friends who are now expert W/T Operators in the Services ?

There is nothing more annoying to a good operator than to have to read slowly sent and badly spaced morse code messages ; many of them are not even patient enough to try to read them.

Why not make sure that your Receiving is at least in the 20 w.p.m. (or more) class, and your sending accurate, well spaced and not below that speed ?

### LEARN MORSE CODE THE CANDLER WAY

There are Courses for Beginners as well as for Operators who wish to increase their w.p.m. speeds and improve their technique. Send for

### THE CANDLER "BOOK OF FACTS"

It is sent post free, and, to request a copy does not place you under the slightest obligation. Write to:—

### CANDLER SYSTEM CO.

(Room 55), 121 Kingsway, London, W.C.2  
Candler System Co., Denver, Colorado, U.S.A.

(244)

# YOU can become a first-class RADIO ENGINEER

We are specialists in Home-Study Tuition in Radio, Television and Mathematics. Post coupon now for free booklet and learn how you can qualify for well-paid employment or profitable spare-time work.

## T. & C. RADIO COLLEGE 2 The Mall, Ealing, W.5

(Post in unsealed envelope, 1d. stamp.)

Please send me free details of your Home-Study Mathematics and Radio Courses.

NAME .....

ADDRESS .....

W.W.39

### CHARLES BRITAIN RADIO (K. H. Ede)

offers bargains in new radio spares. SERVICE kits: No. 1, one 8mfd 450v tubular and 12 asstd. conds. (inc. 1 $\frac{1}{2}$ ), 11/6; No. 2, two 16mfd 200v cans, two 2mfd 25v cans, and two 25mfd 50v cans, and 12 ceramics, 25/-; No. 3, two 8mfd 450v tubs, two 4's 250v, two 2mfd Manesbridge, 24 asstd. conds., 32/6.

ROTARY transformers, input 11v, output 480v ac 40mA, 35/6; heavy duty chokes (ex-H.M.V.), 12/- ea.; Celestion output trans., C.T., 3-ohm, 7/6 ea.; 2-gang conds., 0.0005 midget type, with trims, 13/6 ea.; 3-gang conds., 10/6 ea.; trimmers, 40 pfd-50 pfd, 4/6 doz; knobs, brass inserts,  $\frac{1}{2}$ in spin, 1 $\frac{1}{2}$ in dia., 8/6 doz; 1 $\frac{1}{2}$ , 7/6 doz; pointer knobs, 8/6 doz.

CENTRALAB volume controls, with switch,  $\frac{1}{4}$ ,  $\frac{1}{2}$  and 1 meg., 6/- ea.; Dubilier less switch, all values, 3/6 ea.; socket strips A and E, or P.U., 6/- doz; voltage adjustment strip with tap, 1/- ea.; tubular cond. (Phillips), N.I., prices per doz: 0.1 600v wkg, 10/-; 0.1 500v wkg, 8/6; 400v wkg, 6/6; 0.05-0.01 1,000v test, 6/6; 0.005-0.001, 5/-; mica, 0.0001-0.0005, 5/-; ceramic, 3pfd-470, 3/-.

THIS month's special offer.—Short-wave tuning condensers, 0.00015, beautifully made, on ceramic base with long spindle, 8/6 ea. Terms, cash or c.o.d. over £2; Charles Britain Radio, (temp. address), Eureka, Surrey Gardens, Effingham, Surrey. [372]

GRAMPIAN MCR moving coil microphones, £4/4; microphone transformer, 15/-; D104 crystal insets, £3; mains transformer, 350-0-350v, 120mA, 6.3v, 5v, 25/-.—Aneley Radio, Hindmans Rd., London, S.E.22.

VOLUME controls with switch, 100,000 $\Omega$ , 5/6 each; Pen. 4DD, AC2 Pen. DD, 42MP Pen., 125/7, Pen. 3520, most other types, list price; pen. output speech trans, 9/- ea.; line cord, extra qual. 2-way, 4/6 yd.—Harris Electrical, Ltd., 44, Clarence Rd., Hackney, E.5.

EX-Government stock.—Meters, 1st grade 2 $\frac{1}{2}$ in movements, Ferranti 1,500v electrostatic, 80/- ea.; 500-0-500 microamps, centre zero, 60/- ea.; 150 ma. M.C. milliammeters, 27/6 ea.; 20v. moving iron, 18/6 ea.; mains transformers, 500-0-500v, 150ma. (twice) 4v. 2a. (twice), 65/6 ea.; condensers: 3-gang ceramic ins., 0.0005-10/- ea.; 2-gang 43 pfd. ceramic ins., 7/6 ea.; electrolytics, 50 mfd., 50v., 2/6 each; 2 mfd., 250v., 3/- ea.; tubulars, 0.1mfd, 450v., 6d. ea.; 0.25mfd., 500v., 9d. each; Toggle sw. Bulgis S.P., 1/6 ea.;

Yaxley 3 posn. 5-bank, 7/6 ea.; Morganite pots., 100,000, 1 meg., 2 meg., med. spindles, 2/- ea.; resistors,  $\frac{1}{4}$ ,  $\frac{1}{2}$ , 1 watt, 50 assorted, all useful values, 10/6; Eddystone flexible couplers, 1/3 ea.; s.a.e. for list.—Heathcote, 24, Durnford Ave., Urmston, Manchester.

SUPREME RADIO, 746, Romford Rd., Manor Park, London, E.12. Tel. III. 1260. EVERYTHING for the radio engineer; if you could see our stock it would surprise you; over 3,000 valves, all types, and component parts not listed here; s.a.e. with enquiries; it pays our local customers, so why not you? speakers, 3 $\frac{1}{2}$ in, 5in, 6in, 8in, 10in, prices on application; speaker trans., power and pen., 7/6; speaker cabinets, 8in fitting, colours gold, blue, green, grey, cream, with silk, nice finish, 17/6; mains trans., 4v 2amp, 4v 5a, 350-350 and 5v 2a, 6v 4a, 19/6; mains droppers, 0.2a, 1,000 ohms, 4/6; 0.3a, 5/3; smoothing chokes, 100mfd, 300 ohms, 10/6; wire wound v.c., 2,000, 1,000 ohm sw, 5/6; v.c.s with sw. all sizes, 5/3; less sw. 4/-; slow motion drives, 1/-; wave ch. sws., m. and l., 10d.; midget dials, 4in x 5in, all wave, 1/9; midget coils, a. and h.f., trf fittings, and circuit, 8/6 pr., m. and l. 10/6; line cords, 0.2, 2-way, 250 ohms to 500, 4/6; 3-way, 600 ohms per ft., 5/6 yd.; 2-way, 4/6 yd; knobs, 9/- doz; triple trimmers, 40 pfd, 1/6 set; valve holders, caps, screw wire, connecting wire, bias condensers, resistance, all valves, gangs; cash with order, no o.d.; 6d. extra post.

COULPHONE RADIO, Station Rd., New Longton, nr. Preston (proprietor C. Coulborn).—I supply new goods only and guarantee all goods with the exception of electrolytic condensers and B.V.A. valves for a period of six months. Mail order only, no c.o.d. All orders over 5/- post free, orders under 5/- postage 6d. extra. The following is an extract from a typical letter of the hundreds in the same strain which I receive: "I have been dealing with you now for some 18 months and have never yet received a component which was in any way faulty or shoddy. Your prices compare favourably with other firms."

Your greatest asset, however, is the amazing speed with which you execute orders. All goods advertised in April issue still available, together with the following new lines: 6 $\frac{1}{2}$ in Magnavox p.m. speakers, with pentode transformer, 27/-; 3 $\frac{1}{2}$ in Goodmans p.m. speakers, less trans, 29/-; 12in Vitavox K12/20 p.m. 15 $\Omega$ , £7; limited supplies of 450v wkg. electrolytics, 4mfd 5/-, 8mfd 9/6, 8-8mfd 12/6. Send s.a.e. for latest list. [3710]

# GALPINS

## ELECTRICAL STORES

### "FAIRVIEW,"

## LONDON ROAD, WROTHAM, KENT.

TERMS: Cash with order. No C.O.D.  
All prices include carriage or postage.

ELECTRIC LIGHT CHECK METERS, first-class condition, electrically guaranteed, for A.C. mains, 200/250 volts 50 cy. 1 phase 5 amp. load, each 12/6.

SOLID BRASS LAMPS (wing type), one-hole mounting, fitted double contact, S.B.C. holder, and 12 volt 18 watt bulb. 4/-.

TUNGSTEN CONTACTS,  $\frac{1}{4}$ in. dia., a pair mounted on spring blades, also two high quality pure silver contacts,  $\frac{1}{4}$ in. dia., also on spring blades, fit for heavy duty, new and unused. There is enough base to remove for other work. Set of four contacts, 4/-.

ROTARY CONVERTER, input 40 volts D.C., output 75v., 75 mA, A.C., also would make good 50v. motor or would generate. £2.

AUTO TRANSFORMERS. Step up or down, tapped 0-110-200-220-240; 1,000 watts. £5.

POWER TRANSFORMER, 4kW, double wound, 400 volts and 220 volts to 110 volts, 50 cycle, single phase. Price £20.

AUTO TRANSFORMER, step up or step down, 500 watts, tapped 0-110-200-220-240 volts. £3 10s.

WATT WIRE END RESISTANCES, new and unused, price per doz., 8/-, our assortment.

MOVING COIL AMPMETER by famous maker. 2in. dia., flush mounting, reading 0-10 amps., F.S.D., 20 mA, price 27/6.

AMPLIFIER COMPONENTS from dismantled American 10 and 20 watt amplifiers, all metal cases and compound fitted.

INPUT TRANSFORMERS, ratio 12 to 1, centre tapped, price 15/-.

P.P. OUTPUT TRANSFORMER, ratio 6.2 to 1, centre tapped, price 10/-.

BLOCK CONDENSERS, cap. 10 MF., 250v. D.C. working, 7/6 each.

CABINET LOUDSPEAKER, for extension only, 5 watt output, 8in. dia. cone, high quality, size of cabinet 16 x 14 x 4 $\frac{1}{2}$ in. x  $\frac{1}{2}$  inch thick, cabinet slightly marked at top, price £3.

SMALL M.L. ROTARY CONVERTER, in cast all. case, size 14 x 4 $\frac{1}{2}$  x 4 $\frac{1}{2}$ in., permanent magnet fields, converters need attention, not guaranteed. 30/-.

POWER TRANSFORMER, suitable for arc welding, input 230v., 50 cycle, 1 PH, output 50 volts at 200 amps, price £17; ditto, output 150 amps, £15; ditto, output 100 amps, £12.

TRANSFORMER for rewinding only, approx. 2kW, weight complete with clamps, 45 lbs., price 30/-.

DYNAMO, slow speed, only 500 r.p.m., output 25v.-10 amps., shunt wound, adjustable brush gear, ball bearing, condition as new, weight 60 lbs., a real high-grade job. Price £7 10s.

50 VOLT MOTOR, D.C., input 4 amps,  $\frac{1}{2}$  h.p., ball bearing, double ended shaft  $\frac{1}{4}$ in. dia., slow speed, only 500 r.p.m., shunt wound, condition as new, also make good slow speed generator. Price 50/-.

AUTO TRANSFORMERS, tapped 0-110-200-220-240v., 1 $\frac{1}{2}$  KW., £7 10s.; 2 KW., £10.

50 VOLT D.C. MOTOR, shunt wound, ball bearing,  $\frac{1}{2}$  h.p., speed 900 r.p.m., in new condition, make good generator. Price £7.

MOVING COIL AND M.I. METERS.  
FOR FULL DETAILS OF ABOVE AND OTHER GOODS, SEND FOR LIST, 2jd.

# WHAT'S THE WATTAGE?



**The Electrical and Radio Engineers' OHM's Law Calculator**

*Examples of problems answered in a flash:*  
 What will be the voltage when current I flows through resistance R?  
 What will be the voltage with watts value W and I current flowing?  
 What is the current flowing where watts value is W and voltage is E?  
 What current will flow through R resistance where voltage is E?  
 What will be the resistance where current I flows at voltage E?  
 What will be the resistance where watts W is at voltage E?  
 What will be the resistance where watts W is at current I?  
 What is the wattage at voltage E through resistance R?  
 What is the wattage of current I through resistance R?  
 What will be the wattage of I current at E voltage?  
 The scales read from 1 millivolt to 1,000 volts. From 1 ohm to 1,000,000 ohms. From 1 milliamp to 10 amperes. From one-tenth of a milliwatt to 10,000 watts.

The calculator is sold complete and with full instructions at Radio Stores and Stationers. If unable to obtain, write to **IONIC LABORATORIES LTD.**, Dent, W., Cranbourne Terrace, SALT HILL, SLOUGH, BUCKS, for name and address of your nearest stockist.

**PRICE**  
**6/6**

## AFTER THE WAR!

The advance in Radio Technique after the war will offer unlimited opportunities of high pay and secure posts for those Radio Engineers who have had the foresight to become technically qualified. How you can do this quickly and easily in your spare time is fully explained in our unique handbook.

Full details are given of A.M.I.E.E., A.M.Brit.I.R.E. City & Guilds Exams, and particulars of up-to-date courses in Wireless Engineering, Radio Servicing, Short Waves, Television, Mathematics, etc., etc.

**We Guarantee "NO PASS—NO FEE"**

Prepare for to-morrow's opportunities and post-war competition by sending for your copy of this very informative 112-page guide NOW—FREE.

**BRITISH INSTITUTE OF ENGINEERING TECHNOLOGY (Dept. 388)**  
 17, Stratford Place, London, W.1



## W. BRYAN SAVAGE LTD.

Expert assistance in the solution of problems relating to

- TRANSFORMERS, CHOKES
- AMPLIFIERS
- POWER UNITS

and Specialised Equipment embodying

### ELECTRONIC CONTROL

WESTMORELAND RD., N.W.9  
 COBDALE 7131

WRITE to Harrison and Co. (Electrical), Ltd., 46, Menelik Rd., London, N.W.2, for particulars of the best lines in radio components in the trade; items from our list include 7 types of coils, chokes, trans., o.p. auto- & mains vol. cont. with & without switch, aeriads & aerial wire, push back wire, tuning & pointer knobs, large selectn. of other useful components.

HENRY'S offer—465 i.f. trans. small size. 15/- pr.; Osc coils, 465 k.c., 3/6; med. wave aerial coils with trimmers, 4/3 ea.; Midget t.r.f. coils, 6/6 pr.; Bulgin twin fuse holders, 2/9; T.C.C. 4x4x2x2x1x0.5 med 450v wkg., 17/6; T.C.C. 2midx1mid 600v wkg., 5/-; Mallory 6v vibrators, 4 pin, 12/6; 2 gang condensers with trimmers 14/-, 3 gang 12/6; W.6 Westector, 5/-; 11-way single pole switches, 5/-; Plessey wire wound v/controls, 5,000, 10,000, 20,000, 4/6; Celestion trols., 5,000, 10,000, 20,000, 27/6; Goodman's Sin. P.M. 22/6, 34/- P.M. 30/-. Send for lists.—Henry's, 5, Harrow Rd., Edgware Rd., London, W.2. [3755]

BATTERY charger kits and rectifiers, micro-phones, pick-ups, electrolytics. Metal rectifier, 12v 2.5amp. type, with transformer and ballast bulb for 2v to 12v charger, needs no ammeter or rheostat, 46/6, post 10d.; rectifier alone 22/6, post 7d. (circuit supplied). As above, but for 2v, 6v only, 38/6, postage 9d.; these kits have large robust components, and are as supplied to official bodies; metal rectifier, 12v lamp type, with transformer and ballast bulb for 2v to 12v charger, 32/6, postage 10d.; rectifier only, with circuit, 9/6, postage 4d.; metal rectifier, 12v 4amp type, a robust, heavy duty type component for high-class equipment, 35/6; or with transformer (120 watt), tapped to charge 6v or 12v, £4, postage 2/-; extra for 5amp. rectifier, as above, 10/-.

METAL rectifier, 2v. half amp type, with transformer, makes ideal trickle charger for 2v cel, 13/6, post 7d.

MAINS transformers, prim 250v sec 21v, tapped at 10v and 14v. 50watt size, suit Westinghouse rectifiers, 26/-, post 9d.

ROTHERMEL D.106 deaf aid microphones, crystal type, 45/-; D.104 crystal microphones, £4/15; also moving coil microphones, very good make, heavy plated housing, equal in every way to a well-known £20 microphone, £4/10; Rothermel bakelite pick-ups, 78/9.—Champion, 43, Uplands Way, London, N.21. Tel. Lab 4457. [3756]

COTTON-COVERED copper instrument wire, 1lb reels, 18, 20, 22, 24 gauges, 1/6; 26, 28 gauges, 1/9; 30, 32g, 2/-; 34g 2/3; silk-covered ditto, 2oz reels, 24, 26, 28g, 1/6; 30, 32, 34, 36g, 1/8; 22g, 2/-; 18g double silk, 1lb, 3/-; A.A. thread screws, 1 gross useful sizes, 2/6; ditto, nuts, 2/6 gross; assorted gross screws and nuts, 2/6; ditto, brass washers, 1/6 gross; fibre washers, 1/6 gr; assorted solder tags, 2/- gr; assorted small eyelets and rivets, 1/3 gr; rubber-covered stranded copper wire, 1d. yard; heavier quality, 1½d. yd; very heavy quality, 2½d. yd; ideal for aeriads, earths, etc.; tinned copper connecting wire, 20ft coil, 6d.; ditto, rubber covered, 10ft, 6d.; finest quality push-back wire, 12 yds, 2/3; single cotton-covered inner copper wire, 25g, 12 yds, 1/8; 50 yds, 3/-; twin bell wire, 12 yds, 1/8; heavier quality, 12 yds, 2/3; flat rubber-covered ditto, 3d. yard; twin flat braided electric cable, 6d. yard; all postage extra.—Post Radio Supplies, 33, Bourne Gardens, London, E.4. [3593]

THE Simplex Four, complete constructional details of this most successful midget ac/dc receiver (total cost of construction £9), including theoretical and full scale layout-wiring diagrams, with instructions, 4/6; midget aerial and h.f.m. wave, high gain, T.R.F. coils, 9/- pair; short wave, aerial and oscillator coils, i.f. at 465kc., 5/6 pair; ditto m. wave coils, 9/- pair; midget 2-gang variable 0.0005mfd condensers, 15/-; midget chassis de luxe, sprayed grey, 10½x6x2in, drilled 4 valve holes, etc., 9/6; Simplex midget chassis, drilled 4 valves, and all component fixing holes, speaker cut-out, etc., electro zinc finish, 11x4½x2in, 7/6; midget dials, m. wave, station names, etc., ivorine, 4x3½in, 2/-; midget chokes, and speaker transformers, 7/6 each; Celestion 40in p.m., with tran., 27/6, 10in ditto, 8in/-; R. and A. 8in M.E. speaker, with tran., 1,200ohms field, 35/-; mains transformers, brand new, Marconi, standard input 350-350, 4v, l.t.s., 35/-; ditto 5v, 6.3v, 30/-; R.G.D. 400-400v, 200ma, three 4v, l.t.s., 45/-; 250mfd, 25v, bakelite case, electrolytic, 4/6; mains droppers 0.5amp, 800ohms, fixing feet, 5/6; volume controls, long spindle with switch, 50,000, 1mg and 2mg, 6/6 each; comprehensive list issued monthly, 2½d.; s.a.e. enquiries; postage all orders.—O. Greenlick, 34, Bancroft Rd., Cambridge Heath Rd., London, E.1. Sts. 1334. [3771]

# BERRICON

## VALVEHOLDER

*A new development in Valveholder design*



An enlarged view of the "Berricon" Beryllium Copper Socket, which maintains low and non-varying contact resistance for indefinite periods.

**RADIO INSTRUMENTS LTD.**  
 Subsidiary of Aeronautical & General Instruments Ltd.

**PURLEY WAY, CROYDON**  
 Phone: THOrnton Heath 3211.

# READY SOON A New AMBASSADOR

**AMPLIFIER with SUPER-HET RECEIVER GIVING 20 WATTS ON MEDIUM & SHORT WAVES**

Further details will gladly be supplied on request. Orders can only be accepted for Priority purposes.

**R. N. FITTON, L<sup>TD</sup>**  
 HUTCHINSON LANE, BRIGHOUSE.  
 Tel: 283 Scottish Distributors  
 BRITISH ELECTRICAL & Mig. Co. Ltd.  
 132, West Campbell St., GLASGOW. Tel. Cen. 3286.

**REWINDS**  
 Armatures, Fields, Transformers, Pick-ups, Fractional H.P. Motors, Speakers Refitted New Cones & Speech Coils.  
 All Guaranteed and promptly executed.  
 Valves, B.V.A. and American, good stocks. Send stamped addressed envelope for list of Radio Spares, and C.O.D. Service.  
**A.D.S. Co.** 261-3-6, Lichfield Road, ASTON, BIRMINGHAM, 6

## SEXTON'S for SALES, SERVICE & SATISFACTION

**AMERICAN RADIO VALVES.** Types as under at controlled prices. 3B24GT, 3B25GT, 4B24GT, 5Y3GT, 8G6, 12B3G, 1C5GT, 1Q5GT, at 11/- each. 6J6GT, 6F9GT, 12J5GT, at 9/2 each. 12B7GT, 12B8GT, 25L6GT, 25A6GT, 6K7GT, 6L7G, 6J7GT, 43G, 1A7GT, 6K6GT, 42G, 6V6G, 38G, at 12/10 each. 6Q9G, 6D6G at 11/- each. 6Q7GT, 45G, 75G, 1177 each. 6A9GT, 6K6GT, at 14/- each. 25B8GT, 12A7G, at 15/3 each. 6U5/6C6S (Magic Eye), 14/8 each, plus 4d. postage.

**LOUDSPEAKERS.** "Goodman's" Midget speaker, 3 1/2 in. size, P.M. 2-3 ohms, 30/- each. "Cellation" 3 in. size, with trans. P.M., 27/6. "Magnavox" 3 in. P.M., with multiratio transformer, 30/- each. "Zola" 5 in. P.M., less transformer, 21/6 each. "Cellation" 10 in. mains energised, 2,000 ohms field, 37/6 each, all post paid.

**TUNING CONDENSERS.** 0005 three-gang large type, with slow-motion drive, mounted on metal frame which can be detached to suit any radio, 12/6 each, post paid. Two-gang Midget type, 12/- each, three-gang, 12/6 each, post paid.

**RADIO service box-spanners, 2, 3, 4, 5, 6, B.A.** wooden-handled, 3/- each, post paid. Steel box-spanners, with tommy bar, set of three, 2, 4, 6, B.A., 2/8, post paid.

**LINE CORD,** 50 ohms per foot, 1/8 per yard. "P" type H.F. and Aerial coils, 4/- per set. Step up or down auto. transformers, 100-watt type, 20/- each.

**LOUDSPEAKER cabinets,** veneered walnut, 19/6 each, cheaper quality, 7/- each.

**ELECTRIC ALARM CLOCKS,** beautiful bakelite casing, perfect timekeeper, gentle waker, for A.C. mains only, 42/- each.

**ELECTRIC SMOOTHING IRONS,** for A.C./D.C. mains with thumb rest, connector guard, etc., 4 lbs. weight, finest nickel finish throughout, complete with 2 yards of heavy flex and connector, 30/-, post paid.

**TERMS—Cash with order only.** We regret that owing to staff shortage we are unable to despatch C.O.D. or pre-forma invoice. Send id. stamp for latest list.

**J. E. SEXTON & CO., LTD.**  
164, Grays Inn Rd., London, W.C.1  
Tel.: Terminus 1304, 4842

## MATRICULATION *Brings Success & Security*

Whatever your age, you can now study for the all-important Matriculation Examination at home on "NO PASS—NO FEE" terms. "MATRIC" is the accepted passport to all careers, and opens up opportunities which would otherwise be completely closed to you. Ensure the success and security of you and yours through post-war difficulties by writing for our valuable "Guide to Matriculation" immediately—FREE.

**B.T.I. (Dept. 114)**  
356, Oxford Street, London, W.1.

**HILL & CHURCHILL**  
BOOKSELLERS  
**SWANAGE DORSET**  
ENGLISH & AMERICAN  
BOOKS IN STOCK ON  
RADIO AND  
TELECOMMUNICATION  
CATALOGUE ON APPLICATION

**A VO stockist.**—Good stocks of avometers for immediate release against contract numbers with priority rating. Unless holding a Government contract don't waste time writing. D.C. Minors 23/10, Uni Minors 28/10, model 40 217/10, model 7 219/10. For particulars of multipliers, shunts and transformers for above send 1d. for illustrated list. Wolf electric drill stockist, now free from restriction; to take up to 1/4 in drill 28/8, 3/4 in 210/10, 1/2 in 215/10; state voltage. Send 1d. for illustrated list. Valve stockist, list prices; Brimar, Coscor, Dario, Ever Ready, Ferranti, Ilivac, Lissen, Marconi, Oram, Mazda, Mullard, Philips, Triotron, Tungram and American. If uncertain of the type required send old valve or sketch showing position of valve in chassis and model number of set. All valves tested before dispatch; we specialise in matched pairs FX6s, 6V6s, etc. Tungsten contacts for Philips tubular converters, sets of 8 3/6. Resistance wires: 1/2 37g 3.2Ω—ohms p.yard max. cur., 9amp, 2/6; 1oz 31g 6.4Ω p.y., max. cur., 52 amp, 3/-; 1oz 33g 8.6Ω p.y., max. cur., 0.42amp, 3/4; 1/2oz 37g 18.5Ω p.y., max. cur., 0.26amp, 2/-; 1/2oz 39g 31.7Ω p.y., max. cur., 0.16amp, 2/2; 1/2oz 41g 44.3Ω p.y., max. cur., 0.14amp, 2/6; 1/2oz 43g 66.2Ω p.y., max. cur., 0.11amp, 3/6. In addition to above we carry complete radio and electrical stocks, and our motto for the last 25 years is, If you can't get from us, get it up. All goods are cash with order, post free over 5/-—Park Radio, 678, Romford Rd., Manor Park, London, E.12. Tel. III. 2066.

**SOUTHERN RADIO'S** wireless bargains.—Special offer of latest radio publications: "Radio Valve Manual," equivalent and alternative American and British types, with all necessary data, 3/6; "Radio Circuits," fully illustrated, receivers, test equipment, etc., 2/-; "Services Signalling Manual," Morse, International code, etc., 1/-; "Amplifiers," fully descriptive circuits, 2/-; "Radio Manual," formulas, tables, colour code, etc., 1/-; Telsen large valves, complete boxed (type W184), 2/6; reaction coils, 0.0001, 0.00015, 1/9; 2md condns., P.O. printed paper type, used but fully guaranteed, high working voltage, 2/6; Ace P.O. mikes, complete with trans., ready for use with any receiver, 7/6; Multicon mica condns., 28 capacities in one, from 0.0001 upwards, 4/-; crystal detectors, complete, 2/6; Dr. Cecil crystals, 6d.; with catwhisker, 9d.; push-back wire, insulated, 25yds for 5/-; insulated sleeving, assorted colours, yd lengths, 3/6 doz; single screened wire, doz yds, 10/-; twin screened wire, 17/- doz yds; metal cased condns., 0.14-0.140, high working voltage, 2/6; power rheostats, Cutler-Hammer, 30ohms, 4/6; push-button switches, 3-way 4/-, 8-way 6/- (all complete with knobs); escutcheons for 8-way p.b. switches, 1/6; p.b. knobs, 6d.; pointer knobs (black or brown), special instrument type for 1/4 in spinilles, 1/-; Erie resistances, brand new, wire ends, 1/4, 1/2, 1 and 2w, mostly low values, but a very useful selection, 100 for 30/-; copper earth rods, 18in, 2/6; heavy duty L.F. chokes, 50hys, 100ma, 250ohms 14/-, 500ohms 16/-, 1,000ohms 17/6; we have for disposal a large quantity of brand new assd. screws, sample 1lb weight, 5/-; soldering tags, including spade ends, 5/- 57; coil formers, ceramic and paxolin, 7/6 per doz; special bargain offer of 50 assd. condns., 20 tubulars, 20 mica condns., 8 silver mica condns. and 2 electrolytic condns., all brand new, 47/6 the parcel of 50; all types of Pyrobit soldering irons available from stock, chassis mounting valve holders, English and American types, all sizes, 1/- ea.; hundreds more bargains.—Southern Radio Supply Co., 46, Lisle St., London, W.C.2. Gerrard 6653. [3023

**WANTED, EXCHANGE, ETC.**  
WANTED, Voigt d.c. twin cone speaker.— [3730] Box 3429.  
WTD., circuit, Ekco A.C.76.—Spencer, Dun- [3658] staffage, Argyll.  
WTD., 12A7 valve.—R. Hall, 5, Clarendon [3683] St., Consett, Co. Durham.  
EX., Philips 747A for Coscor 343 osc., cash [3761] ad.—31, Mortimer Rd., N.1.  
WTD., semi-automatic (Bug) Morse key.— [3734] Price and parities, Box 3431.  
WANTED, 3 DPT Marconi valves.—Lamp- [3728] ard, 2, Lexden Rd., Colchester.  
PORTSMOUTH — FAREHAM.—Will anyone [3696] teach man soldering?—Box 3424.  
WANTED, a few mains transformers.—Hal- [3696] lett, High Beacon, Havering, Essex.  
WTD., rotary converter, input 110v d.c., out- [3412] put 230v. a.c., silent running.—Box 3412.  
WANTED, aluminium or dural foil 0.0002in [3737] thick.—Ellis, 55, Chalkhill Rd., Wemb- ley, Middx.  
WANTED, Hartley-Turner true bass baffle, [3764] with or without speaker.—Hankin, 18, Borough Rd., Petersfield, Hants.  
WE offer cash for good models, communica- [3764] tion and all-wave receivers.—A.C.B. Radio, 44, Widmore Rd., Bromley. [1541]

## AUSTERITY RADIO LIMITED

**SPECIAL KIT!**  
**ULTRA-SHORT & SHORT WAVE SUPERHETERODYNE**

5-100 Metres A.C.  
5 valves (including Rectifier) with 8in. P.M. Speaker, Blue Prints and instructions supplied.  
Price 12 Gns.

— A Guaranteed Receiver —

**MAINS TRANSFORMERS.** 350-0-350; 100 ma. L.T.s. 6.3 v. 5 a.; 4 v. 4 a.; Rec. 5 v. 2 a. 4 v. 2 a.; can be used with international or English valves. Colour coded. Mains Input tapped 200/220/240 A.C. 50/-, post 1/1. 400-0-400; 120 ma.; L.T.s. 4 v. 2 1/2 a.; 4 v. 4 a.; 4 v. 2 a.; 4 v. 2 a.; Long Colour Coded Leads, with high insulation. (200/220/240) Mains Input Tappings. 45/-, post 1/1.  
350-0-350; 80 ma.; 4 v. 4 a.; 4 v. 2 a.; A/O Mains Input 230. 30/-, post 8d.  
300-0-300; 80 ma.; 4 v. 4 a.; 4 v. 2 a.; A/O Mains Input 230. 30/-, post 8d.  
350-0-350. Chassis Mounting, Shrouded, 4 v. 4 a.; Input 200/220/240. 35/-, post 9d.  
300-0-300. 75 ma., Chassis Mounting, Shrouded, 4 v. 4 a.; 4 v. 2 a.; Input 200/220/240. 37/6. Mains Transformers wound to specification.  
**L.F. TRANSFORMERS.** Midget, 3:1, 4:1, 5:1 ratios. 6/- each.  
**L.F. CHOKES,** 15 Hy., 80 ma., 1,000 ohms, tapped at 360 and 640. Price 12/6 each. 30 Hy., 80 ma., 1,000 ohms. Price 17/6. Small 10 Hy., 50 ma., 380 ohms, 8/6.  
**PUSH-PULL** Input Transformers, heavy duty. Split secondary windings ratio 4:1. Price 10/6. Small for Parallel Feed Standard, 6/-.  
**OUTPUT TRANSFORMERS.** Standard Pentode, midget 3 ohms, 7/6. Pentode, small, 8/6. Multiratio, standard, 12/6.  
**I.F. TRANSFORMERS.** 465 kc. with trimmers, screened, hits work. Small, 15/- pair.  
**MIDGET H.F. CHOKES.** 2/6.

## 4-VALVE, 4-WATT GRAMOPHONE AMPLIFIER CHASSIS

Assembled on black Crackle-finished chassis fitted with separate Tone Control, Volume Control with on/off switch, sockets for microphone gramophones and extension speaker. Hum free, good quality reproduction. A.C. only. Input 200/250 v. Size overall, 8 x 6 1/2 x 7 1/2 in. Ready to play. Price, including valves and speaker 10 Gns. Theoretical and practical Blue Prints of the above available separately, 2/6 pair.

**CONDENSERS.** 2-gang, small, 2 trimmers, fixing brackets, 0005 ceramic insulation, boxed, 14/6. Coils. Short Wave, 16 to 50 metres, on Paxolin Formers, colour coded A & H.F. with reaction, boxed matched pairs, 4/- with circuit. Aerial and Oscillator Coils, Long, Medium and Short (16-50 m.) on one former, 12/6 pair. Medium Wave, Midget, 8/6 per pair. Line Cord, 3-core, 3 amp. 60 ohms per foot, 5/- per yard.

**BLUE PRINTS**  
1 Theoretical and 2 Practical, to each of the following circuits, 3/6 per set.  
No. 1. A.C.; T.R.F.; 3 valves, Medium Wave only.  
No. 2. A.C.; T.R.F.; 4 valves, Long, Med. & Short.  
No. 3. A.C.; T.R.F.; 4 valves, Short Wave only.  
No. 4. A.C.; Superhet 4 valves; Short and Medium Waves.  
No. 5. A.C./D.C.; Superhet 4 valves; Short & Med. Waves.  
No. 6. Battery; T.R.F. 3 valves; Long, Medium and Short Waves.  
No. 7. Battery; T.R.F. 4 valves; Long, Medium and Short Waves.  
No. 8. Battery; T.R.F.; 3 valves, Short Wave only.  
No. 9. Battery; T.R.F.; 4 valves, Short Wave only.  
No. 10. Battery; T.R.F.; 4 valves, Short Wave only.  
No. 11. Battery 2 1/2 watt; Amplifier, 3 valves, Push-Pull.

**307, HIGH HOLBORN,**  
LONDON W.C.1. Phone HOLborn 4631

# LASKY'S RADIO

370, Harrow Rd., Paddington, W.9  
(Op. Padd. Hospital.) Phone: Cunningham 1979

## This month's Special Offer! 4-VALVE CONSTRUCTORS KIT

8-waveband. Exceptionally well made chassis size 13 1/2" x 6 1/2" x 3", complete with the following new and guaranteed parts: 2-gang variable .0006 with trimmers and large modern three-band dial and glass. Pointer, Glow Motion disc and drive with pulley wheels, spring, cord and brackets, complete with push button unit with buttons and bakelite enclosure, 2 pilot lamp holders, 2+8 mid. electrolytic condenser, 500 volt wdg. vol. control, 1 meg. with switch, 3 parolin panels A/E, L.S. and P.U., 3 yds. mains lead and plug, knobs, etc. £3 6s. each. Postage and packing 2/- extra.

**SPEAKERS.** Bola 5" P.M., 21/6; 8", 23/6; 6 1/2", 22/6. Goodman's 3 1/2", 3 ohms v.c., 30/-; 5", 22/-; 10", 39/6. 12" Vitavox, 28 10s. 6 1/2" Bola energised, 1,000 ohms field with trans. 32/6. 10" Celestion, with 2-way output trans. P.M., 45/6. 5" Plessey P.M. with trans., 24/6.

**MAINS TRANSFORMERS.** Primary 900/20/40 volt. Sec. 4 v. 4 amp., 4 v. 2 amp. 350-0-350 120 m/a, 30/-; 6.3 and 5 volt types, 135 m/a, 32/6.

**LINE CORD,** exceptionally good quality, 70 ohms per foot, 4/9 yd. Glow Motion Dial and Drive, 2/6 each. Slide entries, insulated type, 4/5. 24 Assorted Condensers as per last month, £1 19s. 6d. post free. Synchronizer, 1 to 5 mm., 1/3 to 4/6 dozen. 2-Gang Condensers, .0005 with ceramic trimmers, 15/6; 15/6; 15/6; 13/6; 2-gang with trimmers, 13/6; less trimmers, 11/6.

Mains Droppers, 2 and 3 amp., 5/9 and 6/6. T.E.F. Midget medium high gain coils, H.F. and aerial, from 5/6 pr. With diagram, 7/6 pr.  
Speaker Transformers, midget types, pentode shrouded 5/9. Class B output, 80 m/a, 9/6. Class B Driver, 9/- Valve Holders, all types, 7/6 dozen. Large Steel Chassis, size 14" x 10 1/2" x 1 1/2", 7/6 each.  
Midget Smoothing Chokes, 500 ohms, 60 m/a, 6/6 each Resistances. Cards of 36 assorted 1/2 and 1 watt £1 1s. 6d. each.  
5,000 new and boxed English and U.S.A. mains and battery valves in stock at list prices. Send id. for lists. See previous adverts. for other goods.  
Send us your requirements, C.O.D., but cash with order preferred.

# WARD ROTARY CONVERTERS

Patrol Electric Generating Plants, H.T. Generators, D.C. Motors, Frequency Changers, etc., up to 25 K.V.A.

## CHAS. F. WARD

37, WHITE POST LANE, HACKNEY WICK, E.9  
Phone: Amherst 1393

**HARRISELEX ANTI-VIBRATION MOUNTINGS**

OR INSTRUMENT MOUNTINGS  
a few types of which are illustrated, have been specially developed to take care of different frequencies and to control vibration. Types and sizes available to carry varying loads (Rubber to metal bonded)

W.T.D., personal evening tuition in radio to standard of service mechanic.—Box 3407.  
W.T.D., radiogram cabinet, with or without motor.—Details, cash price, etc., Higgins, Kelvin, Christchurch Rd., Malvern, Worcs.  
COMMUNICATION receiver wanted, good performance; also Avo model 7, any condition.—Price, particulars to Box 3425. [3704  
24 copies W. World, 1942-43-44, 50/-  
lot; wanted, circuit details Ekco AD65.  
W.T.D. BOLA 12in loudspeaker chassis or Voigt twin ldsprk., ac mod., genuine buyer.  
—Write Dowling, 116, Promenade, Cheltenham.  
NEW boxed valves wanted, any quantity, dealers' and service men's complete stocks bought.—J. Bull and Sons, 246, High St., Harlesden, N.W.10. [2155

W.T.D., rotary converter, 12v or 24v dc input; 230v 120-150 watt ac output.—Full details, Aspdin, King St., Clitheroe. [3740

WANTED, photo-electric cells, British Ostram, Mazda and others, and American Visitron, Cetron and others; all sizes, single tubes, and quantities bought for cash.—Cefa Instruments, 55a, York St., Twickenham, Middx. Tel. Pop. 6597. [3705

WE buy for cash, new, used, radio, electrical equipment all types; especially wanted, radios, radiograms, test equipment, motors, chargers, recording gear, etc.—If you want to sell at the maximum price, call, write or phone to University Radio, Ltd., 22, Lisle St., Leicester Square, W.C.2. Ger. 4447.

URGENTLY required for work of National importance, any back numbers from 1936 to 1944 of any British or American radio magazines, such as "Radiocraft", "Radio News", "Communications", "R.O.A. Bulletin", "Radio", "Wireless Engineer", "Electronics", "Bell Telephone Journal", "Proceedings of I.R.E.", etc., etc.; best prices will be paid; these are required to complete Technical Research Library.—Reply to Mr. Bernard, Bernards (Publishers), Ltd., The Grampians, Western Gate, W.6. Tel. Shepherds Bush 2581 (day and night). [3565

WIRELESS World" back numbers required: 1927, Vol. 20, Nos. 1, 2, 4, 15, 14, 16, 17, 23, 26; 1927, Vol. 21, Nos. 4, 6, 7, 9, 13, 17, 18, 19, 20, 21, 23, 25; 1928, Vols. 22, 23; 1929, Vols. 24, 25; 1930, Vol. 26, Nos. 4, 5, 8, 18, 19, 25, 26; 1930, Vol. 27, Nos. 1, 5, 16, 17, 20, 24, 25; 1931, Vol. 28, Nos. 12, 22; 1931, Vol. 29, Nos. 4, 9, 12, 14, 16, 18, 25; 1932, Vols. 30, 31; 1933, Vols. 32, 33; 1934, Vols. 34, 35; 1935, Vols. 36, 37; 1936, Vols. 38, 39; 1937, Vols. 40, 41; 1939, Vol. 44, No. 19; 1941, Vol. 47, March, April; 1942, October; 1943, Vol. 49, March, April, May, June, November, December. Also "Wireless Engineer": 1932, Vol. 9, February; 1935, Vol. 12, December; 1936, Vol. 13, February; 1941, Vol. 18, May; 1942, Vol. 19, August.—Box 3417. [3686

### REPAIRS AND SERVICE

REWINDS and conversions to mains and output transformers, fields, etc., from 4/6.—4, Brecknock Rd., N.7. [3733

MAINS transformers rewound and constructed to any specification; prompt delivery.—Brown, 3, Bede Burn Rd., Jarrow. [3460

ACCURATE radio rewinds, mains transformers, fields, op. transformers, etc.—Southern Trade Services, 297-299, High St., Croydon. [2882

LOUDSPEAKER repairs, British, American, any make; moderate prices.—Sinclair Speakers, 12, Pembroke St., London, N.1. Terminus 4355. [3308

ALL types of radio receivers serviced; A Murphy and Pilot specialist; valves in stock; sound repairs for 13 years.—T. E. Feyver, F.I.P.R.E., 50, Vine St., Uxbridge.

RADIO repairs quickly executed to all makes, English or American; lowest possible prices.—The Music Box, 89, London Rd., London, S.E.1. (Tel. Waterloo 4460 and 6766.)

"SERVICE with a Smile."—Repairers of all types of British and American receivers; coil rewinds; American valves, spares, line cords.—F.R.I., Ltd., 22, Howland St., W.1. Museum 5675. [1575

MAINS transformers service, repairs, rewinds, or construction to specification of any type, competitive prices and prompt service.—Sturdy Electric Co., Ltd., Dipton, Newcastle-upon-Tyne. [3084

TRANSFORMER rewinds, special designs manufactured, all types fields, chokes, outputs, etc., rewound; moderate charges, quick delivery, guaranteed high-class work.—H. W. Forrest, 67, Burman Rd., Shirley, Birmingham. Sh. 2483. Est. 1922. [3652

REWINDS, mains transformers, field coils, chokes, high-grade workmanship, 7-day delivery; new transformers constructed to customers' specifications singly or in quantities.—Metropolitan Radio Service Co., 1021, Finchley Rd., N.W.11. Speedwell 3000. [3719



# FOR THE RADIO SERVICE MAN, DEALER AND OWNER

The man who enrolls for an I.C.S. Radio Course learns radio thoroughly, completely, practically. When he earns his diploma, he will KNOW radio. We are not content merely to teach the principles of radio, we want to show our students how to apply that training in practical, every-day, radio service work. We train them to be successful!

Special terms for members of H.M. Forces and discharged members of H.M. Armed Forces.

### INTERNATIONAL CORRESPONDENCE SCHOOLS

Dept. 38, International Buildings, Kingsway, London, W.O.2

Please explain fully about your instruction in this subject marked X.

Complete Radio Engineering  
Radio Service Engineering  
Elementary Radio Television

And the following Radio examinations:  
British Institution of Radio Engineers  
P.M.G. Certificate for Wireless Operators  
City and Guilds Telecommunications  
Wireless Operator & Wireless Mechanic, R.A.F.

Name.....Age.....  
Address.....

**Aladdin RADIO CORES**  
for all purposes  
GREENFORD, MIDDx. WAXLOW 2300

**'SELECTEST' is Coming**  
will interest every Electrical and Radio Engineer.  
SALFORD ELECTRICAL INSTRUMENTS LTD.  
PEEL WORKS SALFORD

# ELECTRADIX

SPECIAL OFFERS!

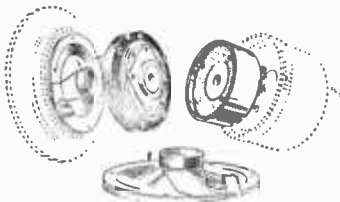

**24/-** for a pair of P.M. MOVING COIL HEADPHONES, less headband. This is one of the finest Electradix Bargains ever offered. The 45 ohm, 1/2" coil is energised by the famous ALNI magnet. These units can be used as miniature speech mikes, or as a small loud-speaker if matching transformer is used. Each unit is in bakelite case with 3" front flange. Per pair 24/-, or 12/6 each.

**SMALL D.C. MOTOR GENERATORS** by E.D.C. and others, for use with Receivers to take the place of H.T. Batteries. Drives off 12-volt accumulator and gives 230 volts D.C. 30 m.a. output. Originally made for Government radios. Two commutators, ball bearings, laminated field, insulated brush gear, covered armature windings. A splendid job. In new condition. 75/-.

**MOTORS A.C.** 230-volt motors, new, 1,425 r.p.m. enclosed type with starting switch incorporated, 1/2 and 1/4 h.p., for prompt delivery.

For other Bargains see p. 29 February and p. 29 March issues.

Please include postage for mail orders.

## ELECTRADIX RADIOS

214, Queenstown Road, Battersea, London, S.W.3

Telephone MACoulay 2159

## ENGINEERING OPPORTUNITIES



This unique handbook shows the easy way to secure A.M.I.Mech.E., A.M.Brit.I.R.E., A.M.I.E.E., City and Guilds, etc.

**WE GUARANTEE— "NO PASS—NO FEE."**

Details are given of over 150 Diploma Courses in all branches of Civil, Mech., Elec., Motor, Aero., Radio, Television and Production Engineering, Training, Building, Govt. Employment, R.A.F. Maths, Matriculation, etc.

Think of the future and send for your copy at once—FREE.

B.I.E.T., 387, SHAKESPEARE HOUSE, 17, STRATFORD PLACE, LONDON, W.1.

## BATTERY CHARGERS & TRICKLE CHARGERS



Trouble-free Chargers fitted with selenium all-metal rectification. Good allowance on your old Charger. Thirty years experience behind every Eureka product. Booklet E.15, describing 12 Models, on request.

RUNBAKEN MANCHESTER 1



**WE LOOK FORWARD** to the time when private enterprise is again free to 'lift' life above the utility level.

**VOIGT PATENTS LTD.**

15, SILVERDALE LONDON, S.E.26

**24-HOUR** service, 6 months' guarantee, any transformer rewind, mains, outputs and i.f.s. etc., all types of new equipment supplied to specification; business heading or service card for trade prices.—Majestic Winding Co., 180, Windham Rd., Bournemouth. [3592]

**T**—radio dealers and service engineers only. Loudspeakers repaired quickly, or materials supplied; also big stocks of all components; send your trade card or billhead and id. stamp for our current lists.—A.W.F. Radio Products, Borough Mills, Sharpe St., Bradford, Yorks. [3410]

**R**EWINDS, mains transformers, layer wound, wax impregnated, chokes, O/P transformers, clock coils, field coils, pick-ups, complete repairs, competitive prices, prompt service, 12 months' guarantee; trade queries invited.—W. Groves, Manufacturing Electrical Engineer, 154, Ickneild Port Rd., Birmingham, 16.

**T**RANSFORMER rewinds and replacement coils, machine layer wound on bakelite formers, interleaved, impregnated and clearly marked, rewinds £1, post paid, standard types to 70 watts; replacement coils, 15/6; larger types and additional secondaries pro rata; discount to trade; delivery by return post most types in common use; state model and iron type when ordering coils; cash with order or c.o.d. fully guaranteed.—Radio Services, Field St. Works, Blackpool, R.T.R.A. Service members. Tel. 1774. [3328]

**D**EGALLIER'S, Ltd.—"Service with a guarantee." If you cannot get your receiver serviced, let American specialists do the job; first-class workmanship only; specialising in Air-King, Belmont, Challenger, Detroit, deWald, Emerson, Ferguson, Garod, Halliorator, Hammerlund, McMurdo, Medwest Majestic, Pilot, Philco, Spartan, etc., also any British set. Remember, for 15 years we have handled as distributors American receivers; this is self-explanatory; s.a.e. with all enquiries.—Degallier's, Ltd., 9, Westbourne Court, London, W.2. [3398]

### MISCELLANEOUS

**POST** Office Megger, in good order; price £5.—John Steel, Bingley. Tel. 1066.

**T**IME recorders.—Write for particulars.—Gledhill-Brook Time Recorders, Ltd., 84, Empire Works, Luddersfield. [2419]

**C**HASSIS, brackets, clamps, shrouds, etc., made quickly, accurately with professional finish in A.A. benders, used by large radio firms, invaluable to experimental engineers.—Full details free from A. A. Tools, 1978, Whiteacre Rd., Ashton-u-Lyne. [3770]

**C**APACITY available for all types of electrical and radio assembly, all types of coil and transformer winding with vacuum impregnation to approved Ministry Super Tropical Standard.—S. Green, 44-45, Tamworth Rd., Croydon. Tel. Croydon 8025. [3517]

**S**YNCHRONOUS motors, Sangamo, 200-250 v. volts ac, 50c, self-starting, fitted reduction gears; ideal movements for time switches, industrial, darkroom, electric clocks, etc.; rotor speed 200 rpm, final speeds available, 1 rev 12mins, 22/8; 1 rev, 30mins, 25/-; 1 rev, 60mins, 25/-; consumption 2 1/2 watts; size 2 1/2 x 2 1/4 x 1 1/4.

**R**EV. counters ex-meters drum type, 0-999, automatic reset to zero on completion; 3/6 each.

**P**ROJECTION lenses, lin focus, ideal for 9.5 or 16mm films, soundheads, etc., oxidised mounts, 1 1/4 in long, 9/16 in diameter; 5/- each; terms, cash with order. Regd. post and packing 1/- extra.—H. Francis, Scientific Stores, 58, New Oxford St., W.C.1. Mus. 8594. [3601]

**E**LECTRIC guitar units, complete constructional details (8 1/2 cap pages plus prints) of three proved and approved electro magnetic units which convert an ordinary guitar to an electric model; my units are being used by professional and amateur guitar players all over the country, 5/-.

**E**LECTRONIC one-string fiddle, an amazing instrument not to be confused with the old-fashioned type, outstanding response and tone; full details, 3/6.

**AC/DC** AMPLIFIER, portable, 6-8 watt output 4 valve plus rect. phase-splitter, neg. current feedback, push-pull output, specially designed for use with above instruments, p.u. or mike; full constructional details, 3/6; stamp for full list of data sheets covering tested and guaranteed designs.

**SPARKS' DATA SHEETS** (W), 9, Phobeth Rd., Brockley, London, S.E.4. [3723]

**S**TOLN, 17-valve Midwest radiogram, model OT-17, large square multi-colour dial, Garrard single 1 in gramo, also 15-valve McMurdo-Silver O/P chassis, separate power pack and 45lb Jensen horn valve, 638s, 7/56s, 1/57, 3/58, power pack 2/45s, 3/80s. Award of £15 will be paid for information leading to the recovery of either set.—Mackenzie Ross, Villina, Angmering-on-Sea, Sussex.

### TUITION

**L**EARN Morse code the Candler way.—See advertisement on this page. [1292]

## LONDON CENTRAL RADIO STORES

NEW GOODS SURPLUS TO GOVERNMENT NEEDS

### WIREWOUND POTENTIOMETERS



4,000 ohms. Open type on porcelain formers. 9/16 spindle 2 1/2 x 1 in. As illustrated. 12/6.

25,000 ohms. Tropical type, enclosed in bakelite moulding, 1/2 in. spindle, 1 1/2 x 1 in. 5/6.

**SPEAKERS.** Goodmans 3 1/2 in. P.M. 3.2 ohms speech coil, less transformer. 30s. Goodmans 1 1/2 in. P.M. 15 ohm V. coil. £8 15s. Carr., etc. 4/6 extra. R. & A. 8 in. mains energised with Pentode output transformer, 1,200 ohm field, 42/6. Celestion 10 in. P.M. with transformer. 47/6. Celestion 6 in. P.M. with transformer. 29/6.

**EXTENSION SPEAKERS**, in Rexine covered Cabinets, 6 in. Bola. 32/6.

**VITREOUS ENAMELLED RESISTORS** 5-watt, 1.5, 500, 1,500, 5,700 ohms, 3/8 ea. 1-watt, 8,000 ohms, 1/- ea. 2 ohms 10-watt approx. 6/8. 23 ohms 0.4 amp. 5/6.

### SLIDING-RESISTANCES

1,100 ohms 0.4 amp. wirewound on twin porcelain formers. A first-class engineering job. 37/6.

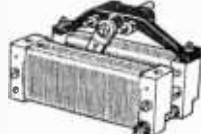

**M**AINS TRANSFORMERS. Made by Philips. A.C. input 100/250 v. Screened primary. 500-0-500 v. 80 m.a., approx., 6.3 v., 12.5 v. Highly impregnated. Colour coded leads to facilitate wiring. 19/6. 300-0-300 75 m.a., 5 v. and 6 v. 32/6.

### TWIN CARBON POTENTIOMETERS

0.5 megohm 8/6.

**D.C. MOVING COIL MILLIAMMETERS** 0-20 m.a., 3 in. clear reading dial. Flush mounting. Made by Ernest Turner Elect. Insts., Ltd. £2 17s. 6d. 0-6 m.a., 2 in. clear reading dial, in 2 1/2 in. flush mounting bakelite case. Extra scales for conversion to voltmeter, and ohmmeter. Internal resistance 250 ohms. £2 17s. 6d. 0-1 m.a. Full scale deflection. £2 15s. 0d.

### TWO-RANGE D.C. VOLTMETERS



Moving coil 0-300, 0-600 v. Complete with shunt. 2 in. clear reading dial. Flush mounting. Made by Ernest Turner Elect. Insts., Ltd. £2 2s. 6d.

**M**IDGET POTMETERS. Wirewound, 8 ohms. 4/6.

**E**LECTROLYTIC CONDENSERS. 60 mfd., 250 v. peak wkg. Metal cased. Insulated terminals. 4 1/2 x 2 1/2 x 1 1/2 in. 15/6. 4 mfd., 800 v. D.C.W. Metal cased. 5 1/2 x 3 x 2 in. 15/6.

**C**ONDENSERS. Metal cased. 0.1 mfd., 1,000 v. D.C.W. Insulated terminals. 2 1/2 x 2 x 1 in. 5/6.

**T**UBULAR CONDENSERS. 0.1 mfd., 350 v. D.C.W. Bakelite with metal ends. Tag terminals. 2/6.

**Y**AKLEY TYPE METER SWITCH. Single pole, 11-way. 6/6.

**"M**UTER" PUSH-BUTTON UNITS. 8-way, with mains switch rated 125 v. at 0.3 amp. and 250 v. at 1 amp. Complete with knobs, but no enclosure. 5/-.

**L**ARGE CHROMIUM-PLATED CHASSIS. Heavy gauge steel, highly polished chromium with "mirror" finish. Size 1 1/2 x 1 1/2 x 3 in. (ends and sides). Drilled for 14 valves, transformer, chokes, etc. A first-class job. Post free. 22/6.

**23, LISLE STREET, LONDON—GERrard 2969—W.O.2**



The  
**"PYROBRAZE"**

Electric Brazing and Soldering Unit in Portable and Robust Metal Cases

For soft-soldering heaviest gauges of wire or sheet—where a soldering iron fails. Produces neat joints in half the time.

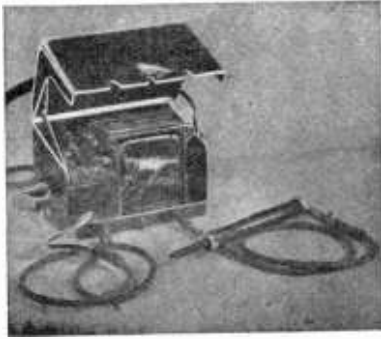

FOR SILVER SOLDERING & BRAZING MEDIUM GAUGES

DELIVERY FROM STOCK  
 ASK FOR LEAFLET

The ACRU Electric Tool Mfg. Co. Ltd.  
 123, HYDE ROAD, ARDWICK, MANCHESTER  
 Telephone: ARDwick 4284

**THESE ARE IN STOCK**

TIME BASES. SCANNING GENERATORS.  
 By O. S. Puckle, M.I.E.E. 16/-. Postage 5d.

FOUNDATIONS OF WIRELESS.  
 By M. G. Scroggie, B.Sc., A.M.I.E.E. 7/6. Postage 4d.

TELEVISION RECEIVING EQUIPMENT.  
 By W. T. Cocking, A.M.I.E.E. 10/6. Postage 4d.

RADIO RECEIVERS AND TRANSMITTERS.  
 By S. W. Amos and F. W. Kellaway. 21/-. Postage 5d.

THE MATHEMATICS OF WIRELESS.  
 By R. Stranger. 7/6. Postage 5d.

WIRELESS WORLD VALVE DATA.  
 Operating condition and base connections of the principles, types and makes. 2/-. Postage 2½d.

VALVE REPLACEMENT MANUAL FOR RADIO SERVICE ENGINEERS.  
 By A. C. Farnell and Arthur Woffenden. 6/-. Postage 2½d.

We have one of the Finest Stocks of Technical Books in the Country.

THE MODERN BOOK CO.  
 (Dept. W.2), 19-23, Praed St., London, W.2.

**AMERICAN MIDGETS HANDBOOK**

Describing with many circuit diagrams the peculiarities of small American (Midget) Radios. Especially written for service men, most likely faults and their remedies with hints on wartime substitutes for unobtainable parts are all given. The valve data section gives bases and working characteristics of the 80 or so valves used in midgets.

Price 2/6  
 from booksellers or by post, 2/8.

V.E.S. (W).  
 Radio House, Melthorne Drive, Ruislip, Middx.

RADIO training.—P.M.G. exams. and I.E.E. Diploma; prospectus free. — Technical College, Hull. [0611]

MATHEMATICS.—Expert personal postal tuition; Metric, Inter. radio maths; prospectus and advice free from B.T.T.C., 8, Ascupart House, Portawood, Southampton.

I.E.E. Corporate Member, successful teacher, can coach limited number private pupils. I.E.E., Brit. I.R.E. and City and Guilds examinations; correspondence only.—Box 3414.

THE Tuitionary Board of the Institute of Practical Radio Engineers have available home study courses covering elementary, theoretical, mathematical, practical and laboratory tuition in radio and television engineering; the text is suitable coaching matter for I.P.R.E., Service-entry and progressive exams; tuitionary fees—at pre-war rates—are moderate.—The Syllabus of Instructional Text may be obtained post free from the Secretary, Bush House, Walton Avenue, Henley-on-Thames, Oxon. [1452]

**SITUATIONS VACANT**

TELEVISION research assistant required, experienced.—Box 3436. [3751]

GLASS blower required for television laboratory.—Box 3437. [3752]

MANAGER and assistant manager required for high-class retail radio and electrical dealer's permanent position with prospects for advancement; Beds and Northants area.—Write, giving details of experience, salary required, Box 3377. [3575]

ASSISTANT works manager required; young man for permanent position; experience desirable in high speed mass production of small components; salary according to experience.—Apply, giving full details of qualifications, experience, etc., Box 3413. [3677]

MANUFACTURERS of radio and electrical components require a sales engineer, preferably with qualifications in electrical and radio engineering, to consolidate and extend existing connections; permanent progressive post for capable, energetic man.—Box 3419.

**SITUATIONS WANTED**

DRAUGHTSMAN-DESIGNER (28), in responsible D.O. position, seeks change, with post-war prospects; pref. S.W. Eng.—Box 3415.

PROGRESSIVE relay and radio service engineer, in responsible position, requires change; 12 years' practical and theoretical experience; permanency only.—Box 3422.

RADIO engineer, 15 years' wide experience, servicing, maintenance of all types British and American receivers, desires representative post, preferably with manufacturer; West (Cheshire area or S.W. Lancs; own car & test equipment.—Please forward enquiries Box 3433.

ADVERTISER, many years' experience radio industry, present senior officer, R.A.F., requires responsible post-war position, charge of large manufacturers' service preferred, used to heavy administrative responsibilities and handling large staff; not frightened of hard work; Service Release Group No. 13; can interview.—Box 3430. [3731]

**PATENT NOTICES**

RADIO-electric patents.—Well-known London radio component manufacturers are open to consider patents or designs for post-war period.—Write Progress, c/o Alfred Bates & Son, Ltd., 130, Fleet St., London, E.C.4.

A UNIVERSAL spool or former support for all small coil winding machines (pat. No. 6766/45). Will firms, etc., interested in the above, to manufacture or obtain on licence, write to H. C. & S., 31, Tennyson St., Lee Mount, Halifax, Yorkshire, Eng. [3700]

THE proprietor of British Patent No. 531963, entitled "Device for producing vibrato in sound amplifying systems and the like," offers same for license or otherwise to ensure practical working in Great Britain.—Inquiries to Singer, Ehler, Stern & Caribers, Steger Building, Chicago, 4, Illinois, U.S.A.

**BOOKS, INSTRUCTIONS, ETC.**

"WIRELESS World," 1917 to 1936, Proc. I.R.E., 1931 to 1938, few missing; also others; what offers?—Box 3401. [3635]

"WIRELESS Worlds," 1921 to 1928, 1930 to 1935, unbound, few missing; "Q.S.T.," 1922 to 1928; early copies of "Wireless Engineer," offers.—Box 3388. [3614]

WEBB'S radio map of the world locates any station heard, size 40x30in, 4/6, post 6d.; on linen, 10/6, post free.—Webb's Radio, 14, Soho St., W.1. Gerrard 2089.

ADAPT your cine projector for sound films! —These books show you how. "Practical Sound Conversion for Amateurs," 5/6; "Adapting the 200B," 3/; "Converting the Kodascope, etc.," 3/6; parts supplied; list, stamp.—Cinelux, Ltd., 88, Greenfield Ave., Carpenders Pk., Watford. [3689]

**ARMSTRONG**

ARMSTRONG has always had the name for Quality.

When this war has been brought to a successful conclusion our new range of ARMSTRONG CHASSIS will prove that our reputation was built on a firm foundation.

ARMSTRONG WIRELESS & TELEVISION CO. LTD.  
 WALTERS ROAD, HOLLOWAY, LONDON, N.7  
 'Phone: NORth 3213

**WELWYN**

HIGH STABILITY  
 CARBON  
 RESISTORS



TROPICAL GRADE  
 TYPE APPROVED  
 CLOSE TOLERANCES  
 LOW TEMPERATURE  
 COEFFICIENT

ENQUIRIES ARE INVITED FROM THE TRADE—CATALOGUE SHORTLY AVAILABLE

WELWYN ELECTRICAL LABORATORIES LIMITED  
 WELWYN GARDEN CITY, HERTS

**COVENTRY—RADIO**

Component Specialists since 1925

- |  |        |
|--|--------|
| POSTAGE STAMP TRIMMERS. 3-30 Pt., 6d.  |        |
| 30-80 Pt., 9d.; 140-250 Pt. ....   | 1 6    |
| TOGGLE SWITCHES. On-off. S.P., 2/8; D.P.   | 2 0    |
| JACK PLUGS. Best quality. Standard .....   | 2 0    |
| L.F. COILS. 16 Henries, 80 ma, 500 Ω .....   | 8 9    |
| OUTPUT TRANSFORMERS. Multi-ratio .....   | 8 9    |
| MAINS TRANSFORMERS. 350-350 volt   |        |
| 90 m/a, 4 volt 4a., 4 volt 2a.; Pri. 0-200/20/40   | 11 9 6 |
| 2-GANG CONDENSERS, 1st grade .....   | 13     |
| Resistors, Condensers, Coils, Wire-wound Potentiometers, Volume Controls, 3½" to 12" Speakers, 1 to 5 Bank Switches, Knobs, Transformers, Instrument Wires, etc. |        |

PROMPT SERVICE, COMPLETE SATISFACTION  
**THE COVENTRY CO.**  
 191, DUNSTABLE ROAD, LUTON.



# ELECTRONIC AIDS *for* INDUSTRY

## *Electronics* will revolutionise paint-spraying

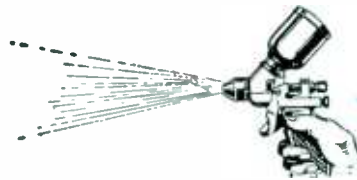

*N*O one can dispute that for speed the spray gun will beat the paint brush every time. But when spraying small objects a lot of paint is inevitably wasted. Further, unless the gun is skilfully used, 'runs' and 'tears' will form, necessitating rubbing down and a re-spray.

Now comes electronic paint-spraying. The object to be sprayed is placed within an electrostatic field which attracts the paint molecules as they leave the gun. Incredible though it may seem, an article can be sprayed simultaneously on all four sides without rotating it! Big savings in time and material are forecast for this new method.

As makers of Capacitors for Radio, Television and Industrial applications we are naturally interested in all electronic developments. Indeed, our Research Engineers are being continually called upon to develop special types to meet new applications. When planning your post-war programme we invite you to submit your capacitor problems to us.



## WHEN YOU BUY SOLDER

WHETHER YOU BUY IT TO REPAIR A SET

TO MAKE ONE SET OR A THOUSAND SETS

IT WILL PAY YOU TO BUY THE BEST—

# ERSIN MULTICORE



The cost of making an average joint in radio equipment when using ERSIN MULTICORE, bought in its smallest package, is one-tenth of a farthing. Naturally, if you bought a ton of ERSIN MULTICORE, each joint would cost you less still. Just one faulty joint can, to put it mildly, cause you considerable annoyance. Isn't it worth while therefore to buy the best? Insist on getting ERSIN MULTICORE—the solder wire with 3 cores of non-corrosive extra active Ersin Flux.

### How can one see the 3 cores in fine gauge ERSIN MULTICORE SOLDER?

Here's the answer: Cutting it on the slant with a very sharp knife may make them clearly visible. A blunt knife just pulls the solder over the cores. This is the way we recommend. Hold a short length of Multicore over a cigarette-lighter flame. As the solder gives, pull sharply. The flux will melt as the solder parts, and the 3 cores will be clearly visible.

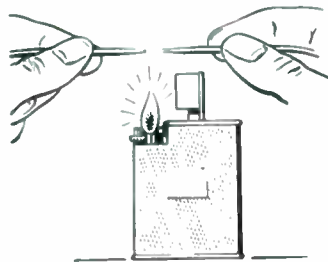

Single reel rate nominal  
1 lb. reels.

**13 SWG - 4/10**  
**16 SWG - 5/3**

Above prices subject to  
usual trade discount.

½ cwt.—ton lots at bulk  
rate. 6d. cartons for home  
use, available at most  
good radio and electrical  
dealers, ironmongers, etc.

## MULTICORE SOLDERS LIMITED

Commonwealth House, New Oxford Street, London, W.C.1. Tel.: CHAncery 5171-2